



Manual & Electric Window Control Systems



# MANUAL WINDOW CONTROL





We are the UK's number one supplier of Manual and Electrically operated Window Control Systems. We offer an extensive range of proven, top quality products, from a variety of manufacturers worldwide to provide the perfect solution to virtually every Natural or Smoke Ventilation requirement. Full technical support and first class customer service ensure you are guaranteed the very best response from initial enquiry to installation.

UK Suppliers of



■ HIGHLINE WINDOW SYSTEM

PAGE

4-11

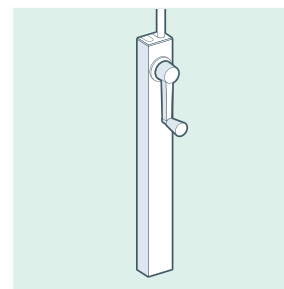
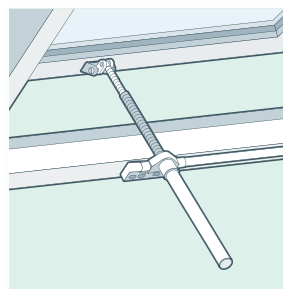
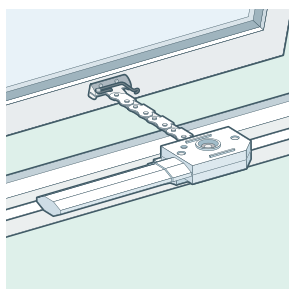

■ SCREWJACK & POLE

PAGE

12-15

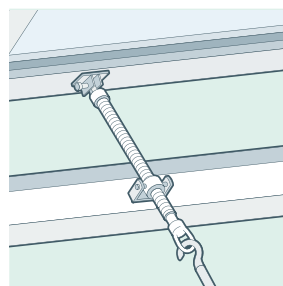
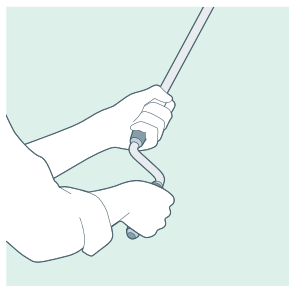





## HIGHLINE®

WINDOW CONTROLS

Manual window controls are used for operating high level or hard to reach windows. The system consists of a manual opener fitted to the opening vent linked via lengths of conduit and cable to a wall mounted operator.

The system is very flexible, as the conduit can be bent around obstructions to allow the operating handle to be positioned at an easy to reach location. Multiple vents can be operated from a single operator.

Various types of operators are available from the most popular Midi Operator to the Maxi Operator for heavier window loads. The system can be fitted to most styles of windows and even be used on rooflights when used with a screwjack opener.



## WINDOW TYPES:

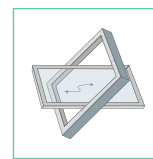
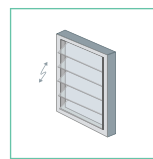
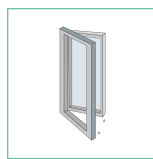
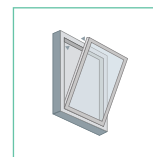
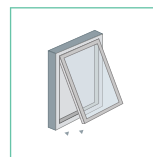
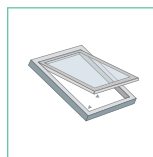

# HIGHLINE WINDOW SYSTEM

## MANUAL WINDOW CONTROL

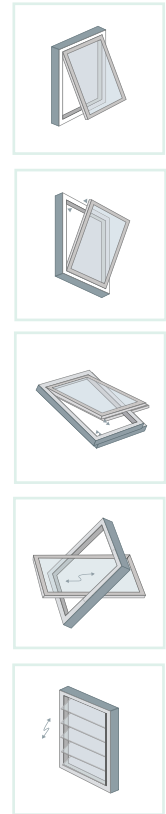
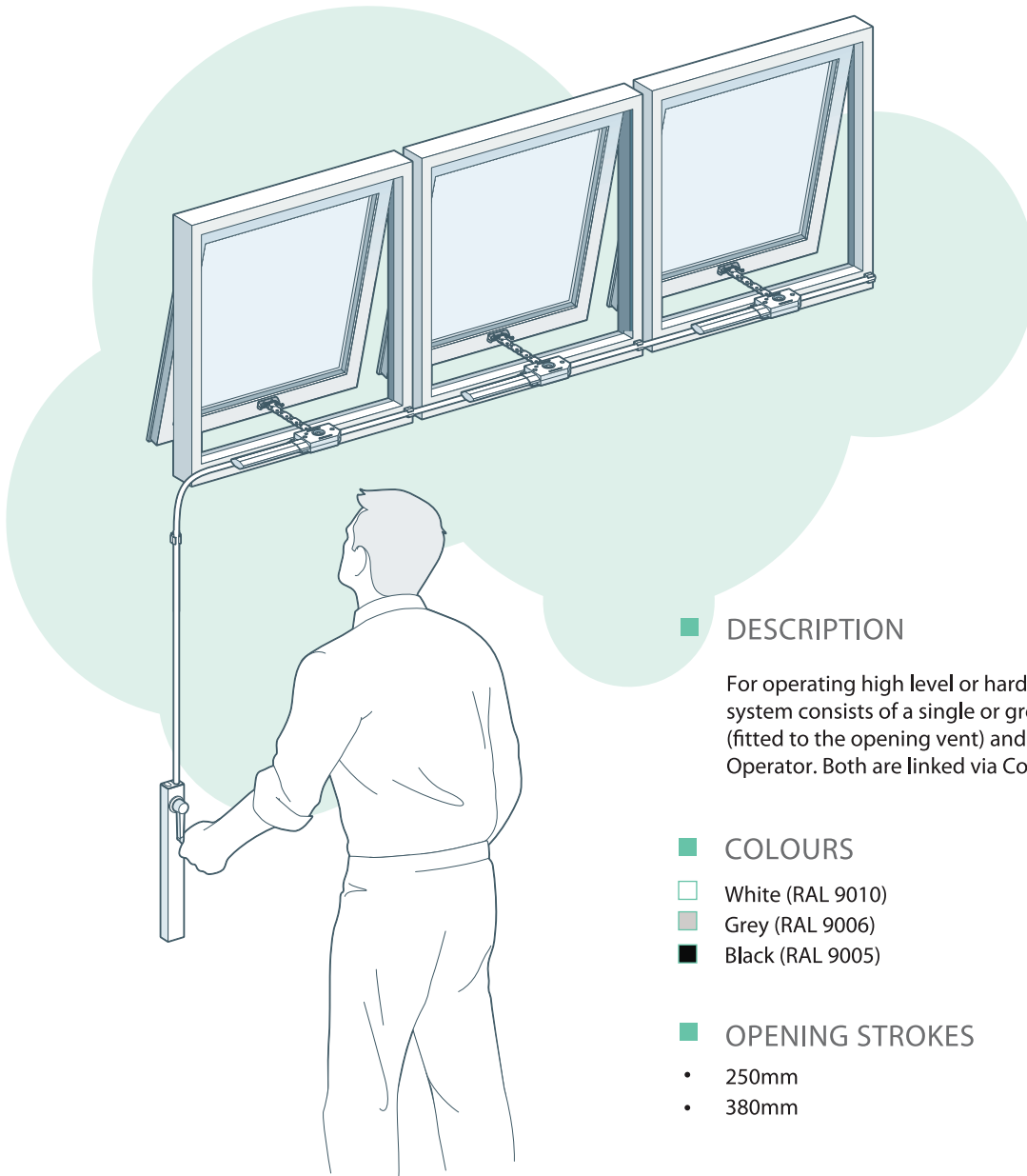

### DESCRIPTION

For operating high level or hard to reach windows. The system consists of a single or group of manual Openers (fitted to the opening vent) and a wall mounted Operator. Both are linked via Conduit & Cable.

### COLOURS

- White (RAL 9010)
- Grey (RAL 9006)
- Black (RAL 9005)

### OPENING STROKES

- 250mm
- 380mm

### FEATURED PRODUCTS

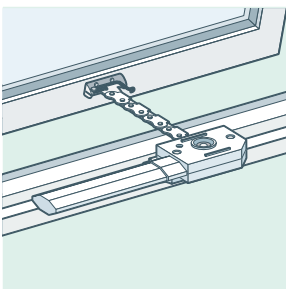

Chain Opener

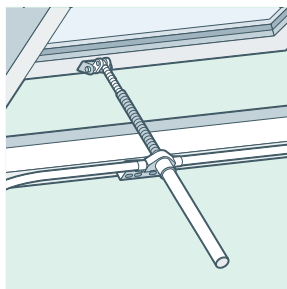

Screwjack Opener

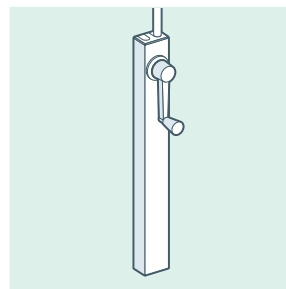

Midi Operator

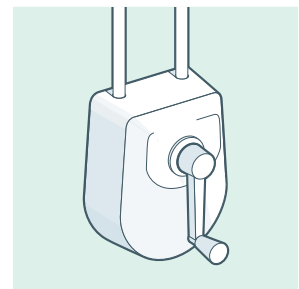

Maxi Operator

“...the solution for most casement types.”

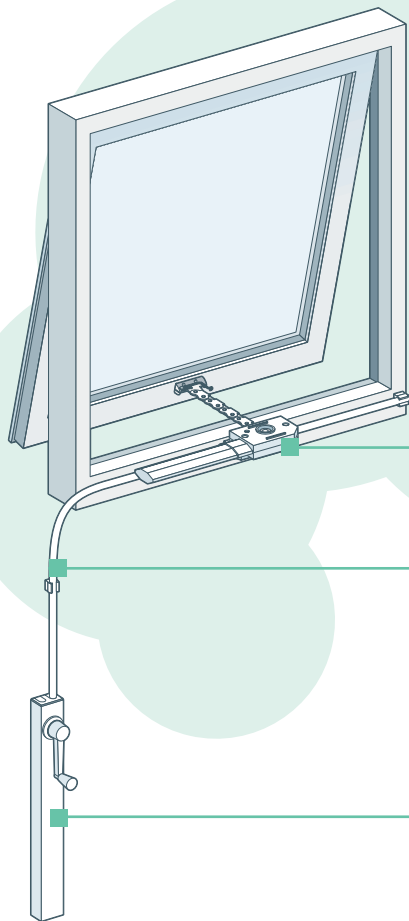

**CHAIN OPENER**

Fixed to outer frame of the opening vent. When cable is driven through it's inner cog the chain inside the opener will push open or pull close the window.

**CONDUIT**

Plastic covered metal tube with nylon inner liner. Used to house inner cable which is driven from Operator to Opener.

**MIDI OPERATOR**

Used to wind inner cable through conduit. The handle can be turned one way to Open the window or turned the other way to Close.

**EXAMPLES**

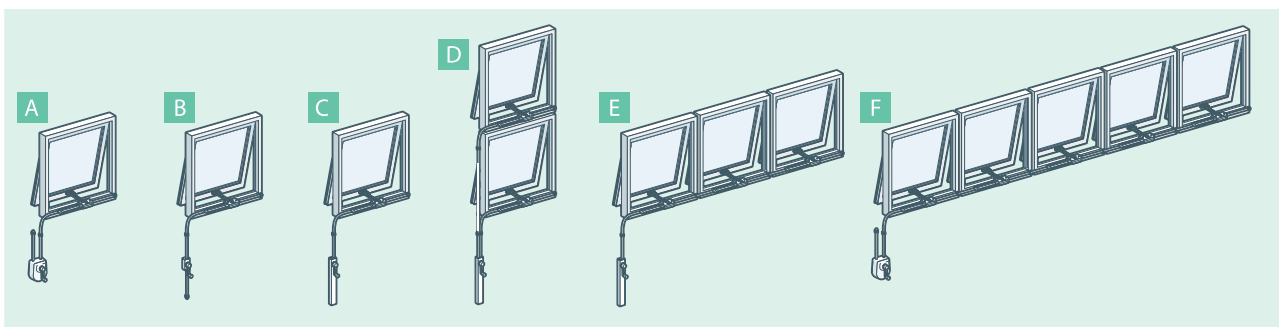

## LOCKING OPENER

“...the solution for inward opening windows.”

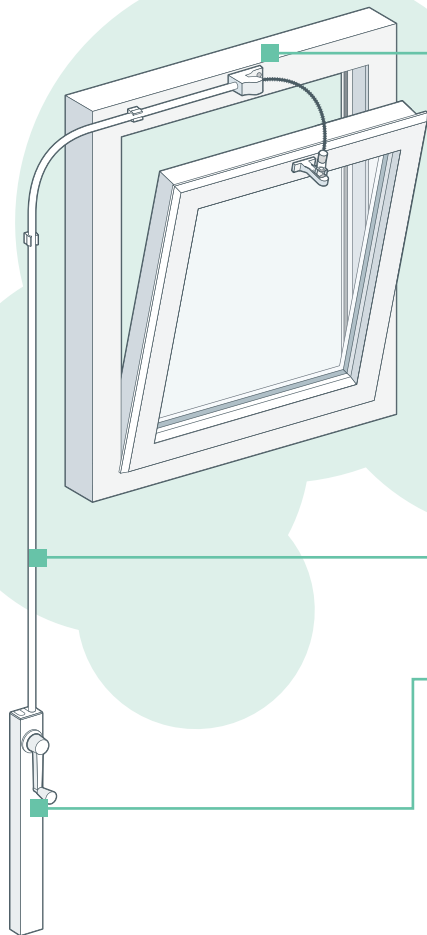

### LOCKING OPENER

Fixed to outer frame of the opening vent. When cable is driven through the unit the opener will push open or pull close the window.

### CONDUIT

Plastic covered metal tube with nylon inner liner. Used to house inner cable which is driven from Operator to Opener.

### MIDI OPERATOR

Used to wind inner cable through conduit. The handle can be turned one way to Open the window or turned the other way to Close.

## EXAMPLES

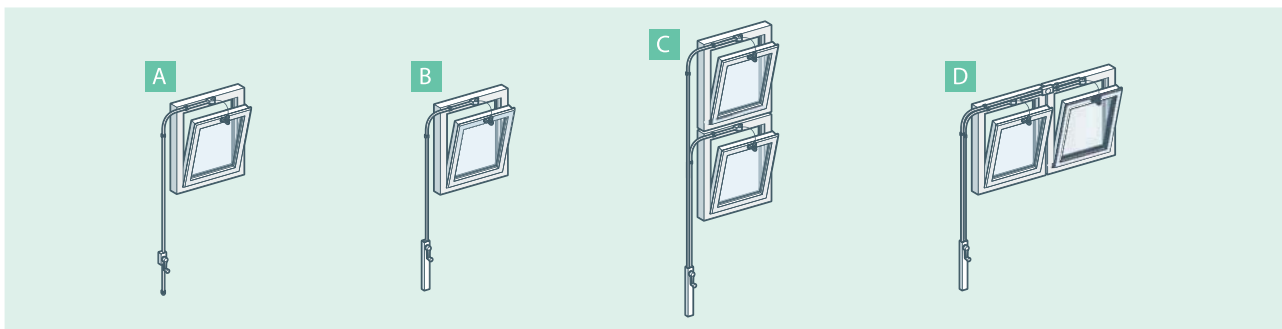



“...the solution for roof vents & sky lights.”

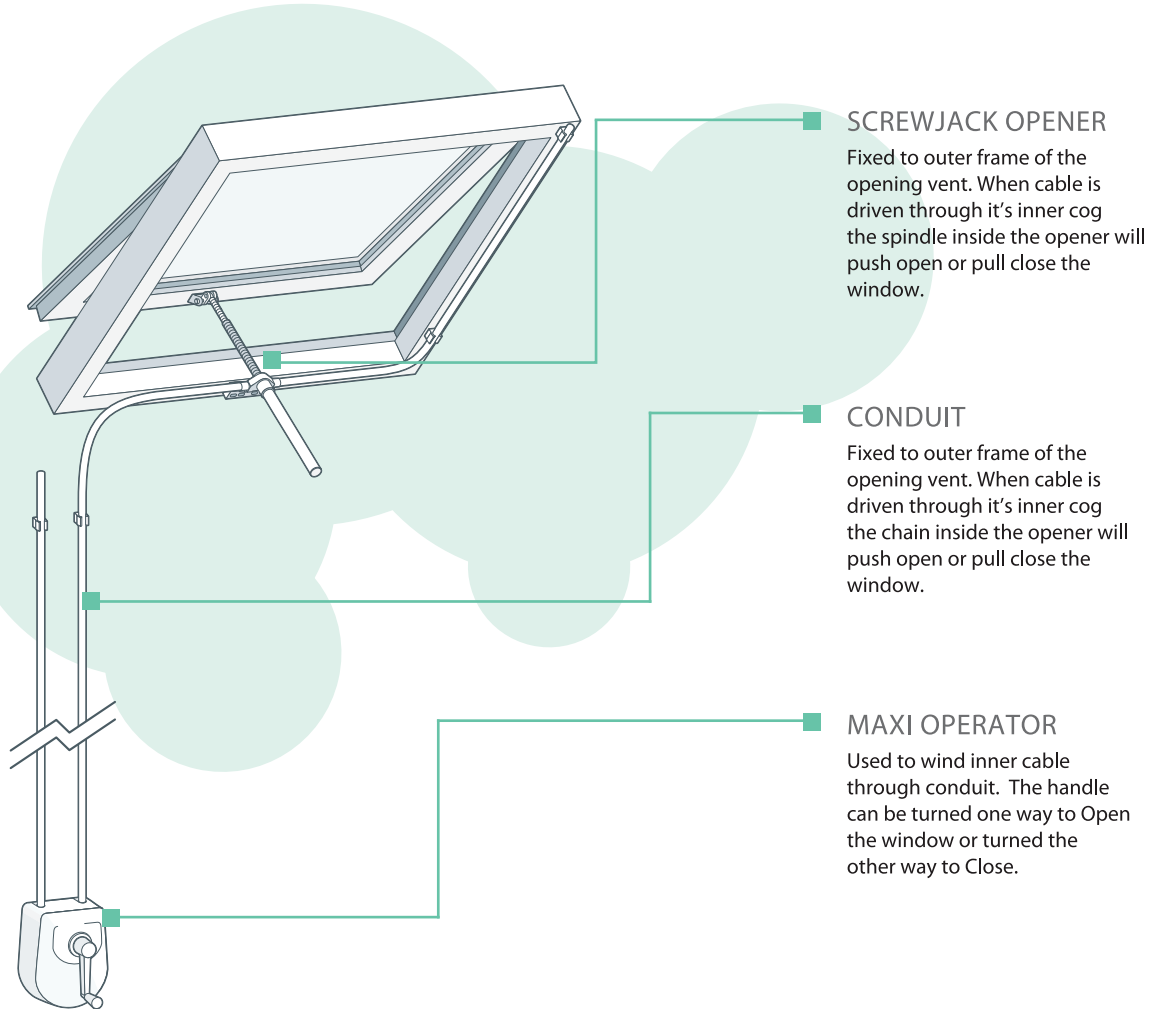

■ EXAMPLES

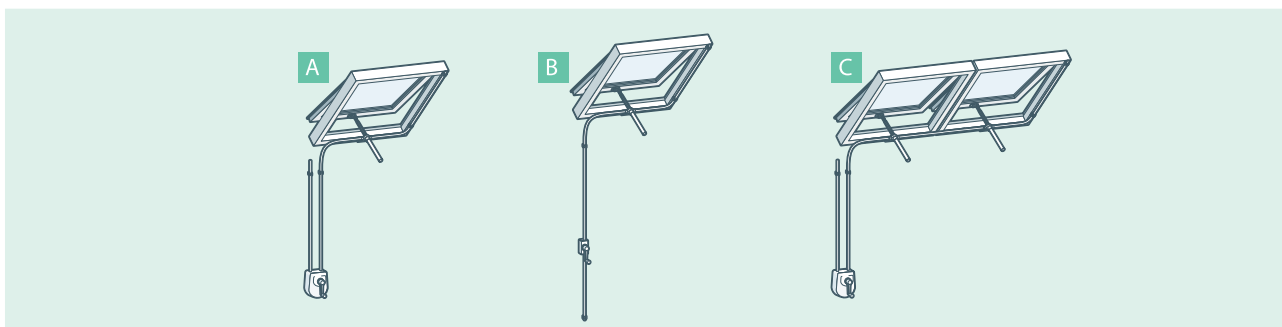

## FORK & SWIVEL OPENER

“...the solution for  
louvre vents.”

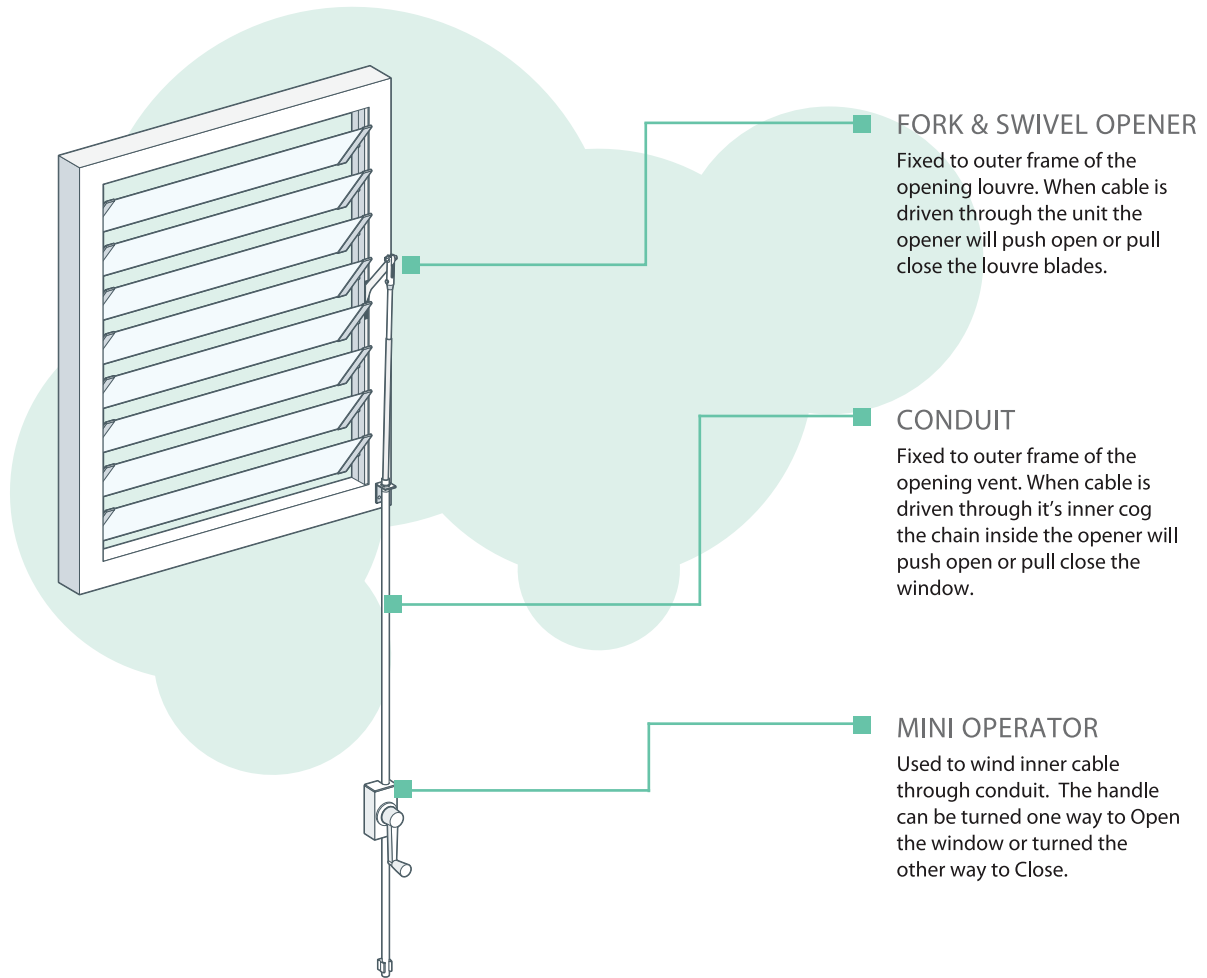

### ■ EXAMPLES

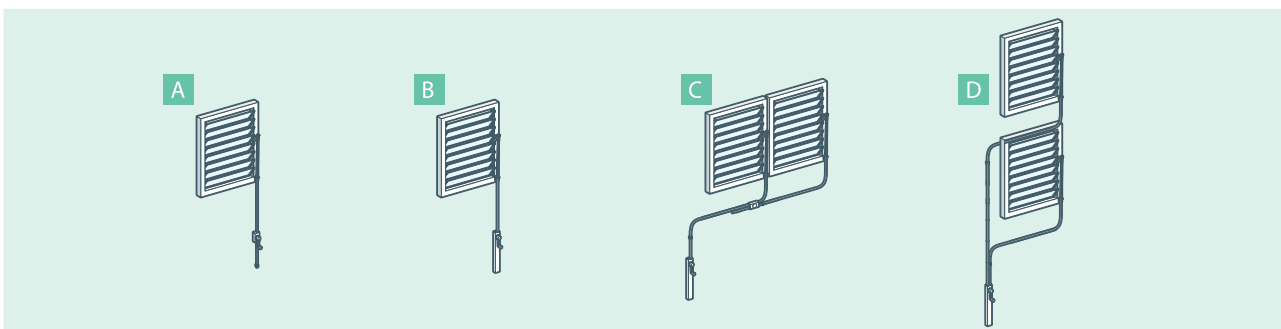

## OPENER

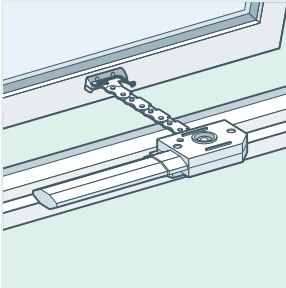

CODE	DESCRIPTION
T100	Chain Opener 250mm
T175	Locking Opener 250mm
T190	Fork & Swivel Opener 250mm
SJ138600	Screwjack Opener 380mm

The above openers are our most popular openers, their suitability will depend on a number of factors. For advice please contact our sales team.

## OPERATOR

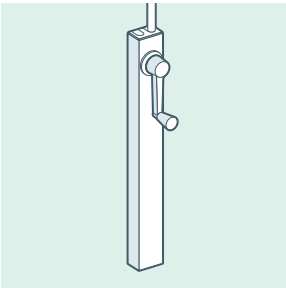

CODE	DESCRIPTION
T210	Maxi Operator c/w Handle
T250	Midi Operator c/w Handle
T300	Mini Operator c/w Handle

The above operators are our most popular operators, their suitability will depend on a number of factors. For advice please contact our sales team.

## ACCESSORIES

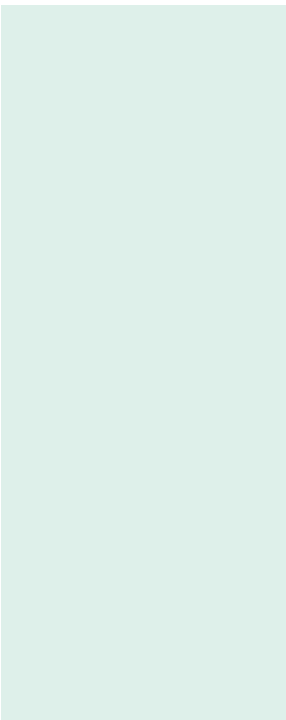

CODE	DESCRIPTION
T400	Conduit 3 metres
T420	Conduit End Cap
T450	Inner Cable
T600	Conduit Saddle Clip
T700	Spring Stop
T720	Brass Stop
T740	Narrow Fixing Plate
T750	Wide Fixing Plate
T760	Angled Fixing Plate
T850	Bottom-Hung Fixing Kit
T900	Conduit Groove Tool
T950	Conduit Bending Tool

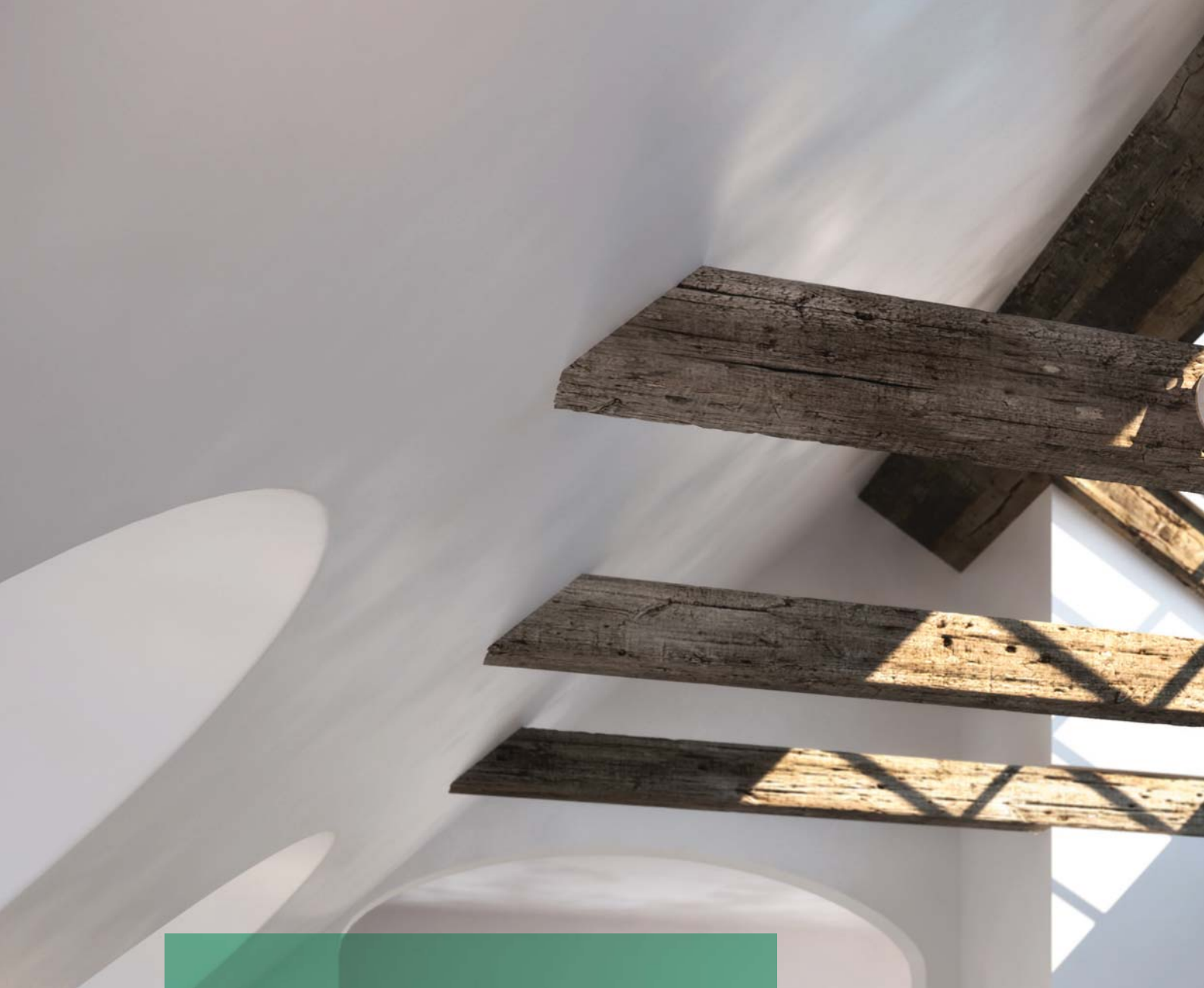

## SCREWJACK & POLE

Screwjack & Pole systems are used for operating high level pitched roof windows.

The system consists of a Screwjack Opener & Winding Pole. The Winding Pole is hooked onto the Screwjack Opener and wound to drive the window Open or Closed.

The system is a cost effective solution in comparison to other ventilation methods. Ideal for use in conservatories or environments that can become hot and stuffy.

Parts can be ordered in Polished Brass or Polishes Chrome finish and come in a range of opening sizes and pole lengths.





## WINDOW TYPES:

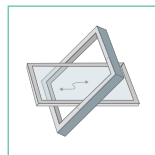
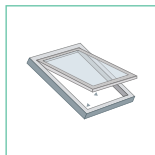

# SCREWJACK & POLE

MANUAL WINDOW CONTROL

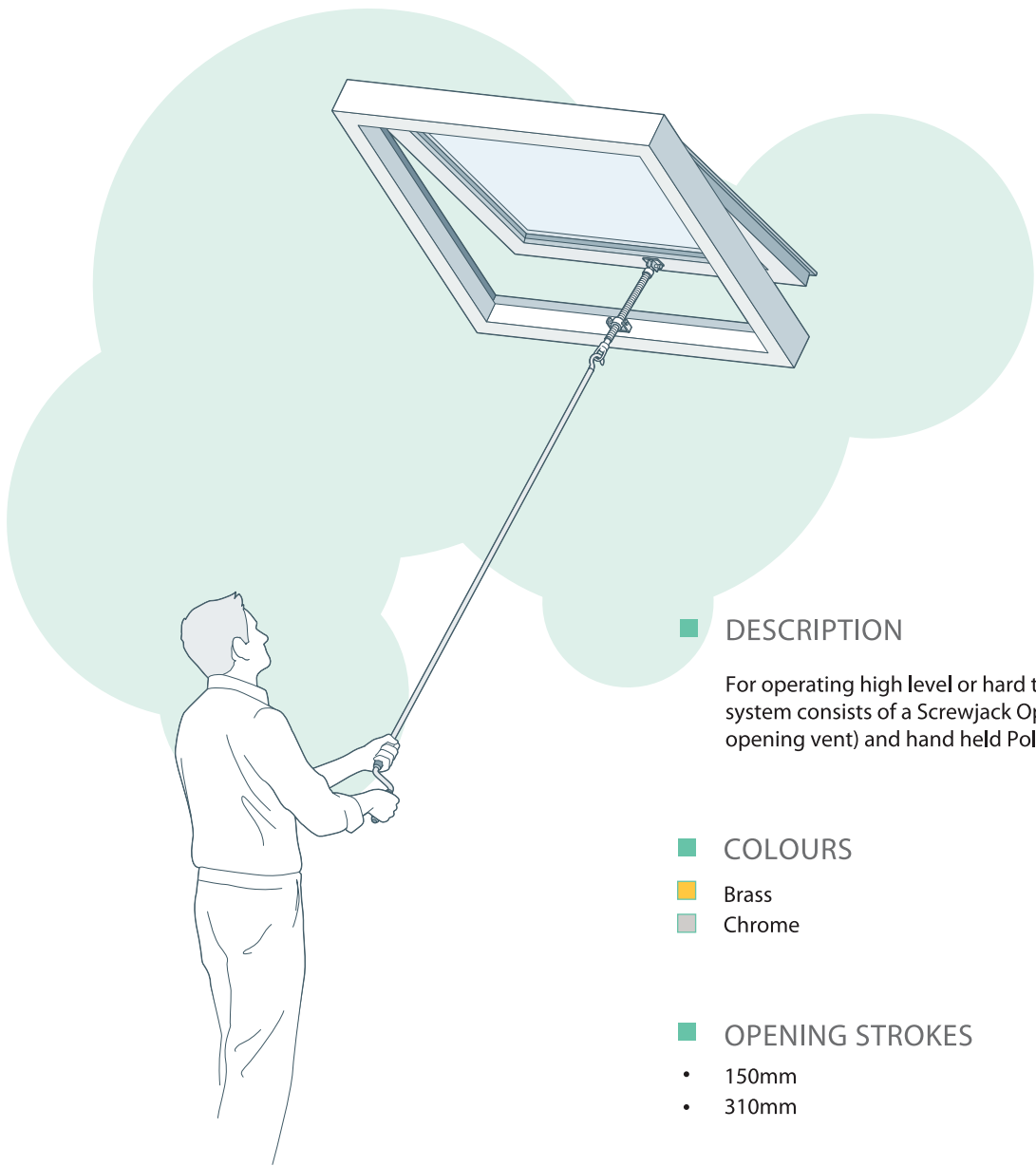
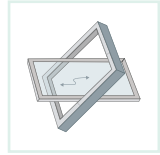
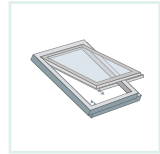

## DESCRIPTION

For operating high level or hard to reach windows. The system consists of a Screwjack Opener (fitted to the opening vent) and hand held Pole Operator.

## COLOURS

- Brass
- Chrome

## OPENING STROKES

- 150mm
- 310mm

## FEATURED PRODUCTS

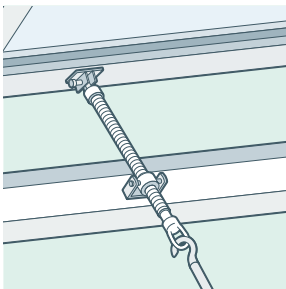

Screwjack Opener



Pole Operator

■ SCREWJACKS

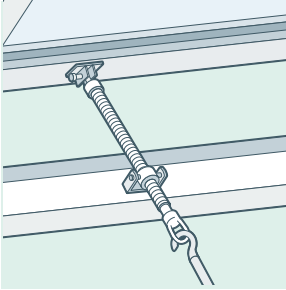

CODE	DESCRIPTION
W3030	Screwjack Opener 310mm c/w Brackets
SJ135-OH	Screwjack Opener 310mm
SJ135-OHT	Screwjack Opener 150mm
SJ154-TOH	Tandem Screwjack Opener 310mm

The above screwjacks are our most popular screwjack openers, their suitability will depend on a number of factors. For advice please contact our sales team.

■ POLES



CODE	DESCRIPTION
W3041	Pole Operator (1.5m or 2m)
SJ87-0H	Pole Operator (1m, 1.5m, 2m, 2.5m, 3m or 4m)
SJ87-VOH	Pole Operator (1-1.8m or 1.75-3m Telescopic)

The above poles are our most popular, their suitability will depend on a number of factors. For advice please contact our sales team.

■ ACCESSORIES

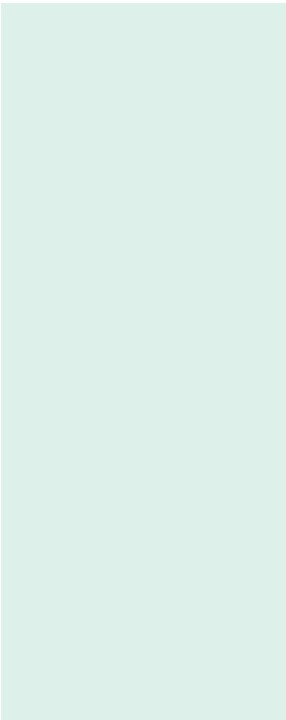

CODE	DESCRIPTION
SJ160	Tandem Connecting Bar (1m, 1.25m, 1.5m or 2m)
SJ169	Upper Bracket
SJ169-236	Upper Bracket
SJ173	Upper Bracket
SJ192	Upper Bracket
SJ198	Upper Bracket
SJ80-7910	Upper Bracket
SJ170-236	Lower Bracket
SJ170-25036	Lower Bracket
SJ80-811	Lower Bracket



Teal Products Ltd  
Unit 8A  
Orchard Trading Estate  
Toddington  
Cheltenham  
GL54 5EB, UK

Tel: +44 (0)1242 620 318  
Fax: +44 (0)1242 622 956



[www.tealproducts.com](http://www.tealproducts.com)  
[sales@tealproducts.co.uk](mailto:sales@tealproducts.co.uk)