

sapa:

DF 75 Si Casement and TBT

Technical Data



Dualframe 75mm Si Tilt Before Turn Window

- 03 Design Features
- 04 Performance Data
- 10 Support Services
- 11 Profiles
- 16 Profile Inertia Values
- 18 General Arrangements Cills

Dualframe 75mm Si Casement Window

- 06 Performance Data
- 08 Specifications
- 10 Support Services
- 13 Profiles
- 17 Profile Inertia Values
- 31 General Arrangements Cills

Specialist Profiles

- 45 Dualframe 75mm Si Tilt Before Turn Window
- 45 Dualframe 75mm Si Casement Window

Contemporary Design: Dualframe signifies a new era in aluminium fenestration, with products that have been specifically designed to comply with the ever increasing complexity of Building Regulations, British Standards and other regulatory demands.

Superior thermal performance: Dualframe comfortably exceeds the requirements of Part L 2010 of the Building Regulations for both thermal insulation and air permeability and has been designed to be compliant with future anticipated changes. Where required, Dualframe 75mm Si Window can achieve an “A” Window Energy Rating and ‘U’ Values down to 0.9 $\text{W/m}^2\text{K}$, also enabling a generic BREEAM ‘A’ rating to be achievable against the Green Guide for Commercial Windows.

Dual colour capability: All Dualframe products can have differing finishes internally and externally.

Integrated Design: The Dualframe Si suite consists of a high performance casement, tilt before turn and MFS, a cost effective alternative to curtain wall allowing the installation of modular units that are constructed off-site and capable of a two story span. The Si range sits alongside the well established Dualframe range which also includes casement and tilt before turn but also comprises pivot, reversible, single and double door configurations.

Unique polyamide thermal barrier With integral bead retention leg to minimise projection of opening lights.

Accreditation: Dualframe Si casement and tilt before turn windows have been awarded BSI Kitemarks to BS4873 ‘Specification for aluminium alloy windows’ and BS7950 ‘Specification for enhanced security performance of casement and tilt before turn windows for domestic applications’.

Dualframe doors have been awarded BSI PAS023-1:1999, ‘General performance requirements for door assemblies; Part 1 – single leaf door assemblies to dwellings’ and PAS024-1:1999 ‘enhanced security performance requirements for door assemblies; Part 1– single leaf external door assemblies to dwellings’.

Dualframe Si casement, tilt before turn, reversible, Dualframe doors and Dualframe MFS meet the Secured by Design specification.

Dualframe 75 casement can achieve an ‘A’ Window Energy Rating (WER) where required.

Aesthetics: Chamfered, Softline and flat vent profiles are available to many products within the Dualframe suite, options of internal or external beading (including BS7950 compliant security) are also available.

Ease of maintenance: The integration of a ‘Eurogroove’ feature enables use of industry standard hardware, available from a variety of sources so that the product is competitive and easily maintained.

Product

Dualframe 75mm Si Tilt Before Turn Window, Dualframe 75mm Si Casement Window, Dualframe 75mm Si MFS (Modular Facade System)

Design Variants

Can be constructed to form fixed and opening lights either as combination frames or as separate coupled lights.

Compatibility

Can also be integrated with other products from the Dualframe range, Crown and Elegance 52 ranges.

Application

Suitable for installation in new build or replacement projects in residential, commercial or public buildings.

Finishes

A wide range of polyester powder coat finishes is available to BS EN 12206:1 2004. Anodised finishes are to BS3987 Grade AA25 etch silver with a range of special anodised finishes on application.

For more details, or to talk to a Project Consultant, contact the Marketing Team on 01684 853500.



BSI Registered firm
Licence No. FM0114



BS 4873
Licence No. KM74159



BS 7950
Licence No. KM74141



PAS 23-1 & PAS 24-1
Licence No. KM90215

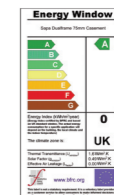

Doorsets PAS 23 & 24
Certificate Number 044



BS7950 & BS4873
Certificate Number 034



Aluminium Windows
BS 4873
Certificate Number 001



Official Police Security Initiative



ISO 14001

Materials

Aluminium profiles are extruded from aluminium alloy 6063 or 6060 T6 complying with the recommendations of BS EN 755-9:2007. Polyester powder coat finishes are available to BS EN 12206-1:2004 in a wide range of colours. Anodised finishes are to BS 3987 Grade AA25 etch silver as standard, with a range of special anodised finishes on application.

Weatherstripping is a TPE seal internally and externally, both set in undercut grooves in the sash and frame.

Construction

Frame members are square or mitre cut at 45°. Corners are reinforced with stainless steel corner ties and die cast zinc corner cleats where required. All joints shall be sealed during fabrication against water entry.

The thermal barrier section is achieved using two separate aluminium extrusions and two bespoke polamide extrusions mechanically jointed to form a single compound profile.

Integral reverse rebate units can be manufactured using the unique reverse rebate frames and adaptors, to form a glaze out fixed light, next to a tilt before turn window.

Authority

BS7950: Specification for enhanced security performance of casement and tilt/turn windows for domestic applications.

BS4873: Aluminium Alloy Windows.

BS6375-1: Performance of windows: Classification for weather tightness and guidance on selection and specification.

BS6375-2: Performance of windows. Specification for operation and strength characteristics.

BS6262: Code of practice for glazing for buildings.

BS EN 755-9: Aluminium and aluminium alloys. Extruded rod/bar, tube and profiles. Profiles, tolerances on dimensions and form.

BS3987: Specification for anodic oxide coatings on wrought aluminium for external architectural applications.

BS EN 12206:1 2004: Specification for powder organic coatings for application and stoving to aluminium alloy extrusions, sheet and perforated sections for external architectural purposes.

BS EN 10077-2: Thermal performance of windows, doors and shutters – calculation of thermal transmittance – Part 2: Numerical method for frames.

Site Work

A fabrication, installation and glazing service is available through a network of fabricators and installers. For details of suitable fabricators and installers, please contact our Marketing Team on 01684 853500.

Hardware & Security

Opening lights are hung on concealed, zinc plated steel, tilt before turn gear with locking cams and zinc plated zinc die cast keeps. Handles can be colour matched and are aluminium die castings. Handles are of the 'safety locking' type which means that the turn mode can be locked off to unauthorised users. Security keeps must be fitted when enhanced security to BS7950 is required.

Glazing

Drainage in accordance with details listed in this manual meets the requirements of "Ventilated and Drained Glazing System", as specified in BS6262. Glass must conform to BS6262 for thickness and type. Insulating glass units of 24mm, 28mm and 32mm can be accommodated.

Glass is set against extruded synthetic rubber gaskets retained in undercut grooves within the aluminium profile. Final retention of the glass is achieved by the application of a co-extruded PVCu/ synthetic rubber wedge gasket between the inner face of the glass and the bead.

Weather Performance

When tested in accordance with BS6375:Part 1:2004 all products listed in this data sheet, when manufactured, installed and glazed strictly in accordance with Sapa Building Systems' specifications, will achieve the following exposure category '2400 Special'.

Opening Lights

Water Tightness Class 9A (600 pascals)
 Permeability Class 4 (600 pascals)
 Wind Resistance Class E (2400 pascals)*

Fixed Lights

Water Tightness Class 9A (600 pascals)
 Air Permeability Class 4 (600 pascals)
 Wind Resistance Class E (2400 pascals)*

* Exposure category varies with Width/Height of window and mullion / transom used, as these are the only unsupported members. An accurate figure can be obtained using BS6399 Part 2 calculations and inertia values given on page 14.

Maximum fixed light area = 5m².

Thermal Performance

Dualframe 75mm Si can meet and surpass the area weighted average U values stipulated in Part L of the Building Regulations. Lower U-values can be achieved using double glazed units with enhanced thermal insulation, such as 'soft coat' low emissivity glass, argon gas filling and thermally broken spacer bar.

Security

When security gear is used, and the window is manufactured and glazed in accordance with the manual, the window can conform to the requirements of BS7950:1997

Size Limitations

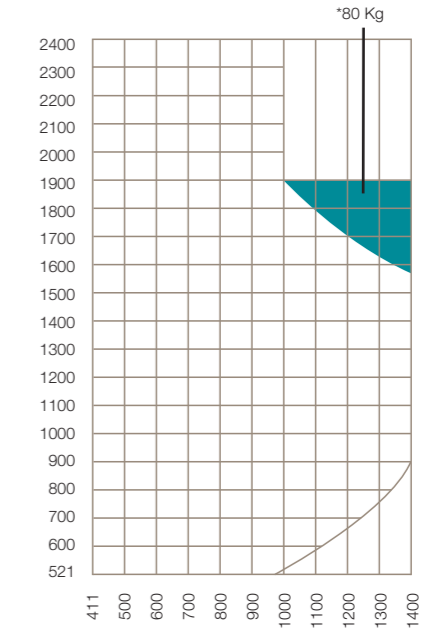

Fixed Light

Maximum area 5 sq.m

Sash Rebate

Minimum Width 411 mm
 Maximum Width 1400 mm
 Minimum Height 521 mm
 Maximum Height 2400 mm
 Maximum Sash Weight 100 kg*

Refer to matrix above for height to width ratio of opening light

*The maximum Sash Weight is reduced to 80 kg in area marked on the matrix above

Materials

Aluminium profiles are extruded from aluminium alloy 6063 or 6060 T6 complying with the recommendations of BS EN 755-9:2001. Polyester powder coat finishes are available to BS EN 12206-1:2004 in a wide range of colours. Anodised finishes are to BS 3987 Grade AA25 etch silver as standard, with a range of special anodised finishes on application.

Weatherstripping is a TPE seal internally and externally, both set in undercut grooves in the sash and frame.

Construction

Frame members are square or mitre cut at 45°. Corners are reinforced with stainless steel corner ties and die cast zinc corner cleats where required. All joints shall be sealed during fabrication against water entry.

The thermal barrier section is achieved using two separate aluminium extrusions and two bespoke polyamide extrusions mechanically jointed to form a single compound profile.

Integral reverse rebate units can be manufactured using the unique reverse rebate frames and adaptors, to form a glaze out fixed light, next to a Tilt before Turn window.

Authority

BS7950: Specification for enhanced security performance of casement and tilt/turn windows for domestic applications.

BS4873: Aluminium Alloy Windows.

BS6375-1: Performance of windows: Classification for weather tightness and guidance on selection and specification.

BS6375-2: Performance of windows. Specification for operation and strength characteristics.

BS6262: Code of practice for glazing for buildings.

BS EN 755-9: Aluminium and aluminium alloys. Extruded rod/bar, tube and profiles. Profiles, tolerances on dimensions and form.

BS3987: Specification for anodic oxide coatings on wrought aluminium for external architectural applications.

BS EN 12206:1 2004: Specification for powder organic coatings for application and stoving to aluminium alloy extrusions, sheet and perforated sections for external architectural purposes.

BS EN 10077-2: Thermal performance of windows, doors and shutters – calculation of thermal transmittance – Part 2: Numerical method for frames.

Site Work

A fabrication, installation and glazing service is available through a network of fabricators and installers. For details of suitable fabricators and installers, please contact our Marketing Team on 01684 853500.

Hardware & Security

Opening lights are hung on concealed, stainless steel variable geometry friction hinges. Espagnolette locks are zinc plated steel, with zinc plated die cast keeps. Handles can be colour matched and are zinc die castings. Optional Vector Excluder hinge protectors must be fitted when enhanced security to BS7950 is required.

Glazing

Drainage in accordance with details listed in this manual meets the requirements of “Ventilated and Drained Glazing System”, as specified in BS6262. Glass must conform to BS6262 for thickness and type. Insulating glass units of 24mm, 28mm and 32mm can be accommodated.

Glass is set against co-extruded PVCu / Nitrile gaskets retained in undercut grooves within the aluminium profile. Final retention of the glass is achieved by the application of a co-extruded PVCu / Nitrile wedge gasket between the inner face of the glass and bead or frame.

Performance

When tested in accordance with BS6375:Part 1:2009 all products listed in this data sheet, when manufactured, installed and glazed strictly in accordance with Sapa Building Systems’ specifications, will achieve the following exposure category ‘2400 Special’. (see below)

Opening Lights

Water Tightness	Class 9A (600 pascals)
Permeability	Class 4 (600 pascals)
Wind Resistance	Class E (2400 pascals)*

Fixed Lights

Water Tightness	Class 9A (600 pascals)
Air Permeability	Class 3 (600 pascals)
Wind Resistance	Class E (2400 pascals)*

* Exposure category varies with Width/Height of window and mullion / transom used, as these are the only unsupported members. An accurate figure can be obtained using BS6399 Part 2 calculations and inertia values given on page 15.

Maximum fixed light area = 5m².

Thermal Performance

Dualframe 75mm Si can meet and surpass the area weighted average U values stipulated in Part L of the Building Regulations. Lower U-values can be achieved using double glazed units with enhanced thermal insulation, such as ‘soft coat’ low emissivity glass, argon gas filling and thermally broken spacer bar.

Size Limitations

Note All sizes given are in millimetres, all vent maximum and minimum sizes relate to the overall size of the vent frame and not the outerframe.

Vent frame = “B” size + 12mm (see page 4-1 for an explanation of “B” size)

Fixed Light

Maximum area 5 sq.m

Standard Casement Side Hung

Stay Size	8"	12"	16"
Max Width	440	640	740
Max Height	1200	1300	1300
Max Weight	18kg	22kg	24kg
Min Width	250	351	453
Min Height	424	424	424

Top Hung

Size	6"	8"	10"	12"	16"	20"	24"
Max Width	1200	1200	1200	1200	1200	1200	1200
Max Height	340	390	440	590	820	1140	1340
Max Weight	10kg	12kg	16kg	20kg	21kg	26kg	40kg
Min Width	424	424	424	424	424	424	424
Min Height	199	249	315	390	540	740	890

Heavy Duty Casement Side Hung

Stay Size	10"	16"
Max Width	706	884
Max Height	1524	1829
Max Weight	38kg	47kg
Min Width	303	496
Min Height	424	424

Top Hung

Super Heavy Duty

Stay Size	10"	12"	16"	22"	22"
Max Width	1600	1600	1600	1600	1539
Max Height	681	883	1136	1500	1750
Max Weight	37kg	45kg	55kg	75kg	100kg
Min Width	424	424	424	424	541
Min Height	313	681	883	1136	1095

Specification Casement Windows

Top Hung Casement – 8” 12kg Max Weight – Min Width 424

12mm Glazing Thickness		8mm Glazing Thickness	
Height	Width	Height	Width
390	1002	390	1200
374	1044	374	1200
359	1089	359	1200
343	1139	343	1200
327	1193	327	1200
312	1200	312	1200
296	1200	296	1200
280	1200	280	1200
265	1200	265	1200
249	1200	249	1200

Top Hung Casement – 10” 16kg Max Weight – Min Width 424

12mm Glazing Thickness		8mm Glazing Thickness	
Height	Width	Height	Width
440	1184	440	1200
426	1200	426	1200
412	1200	412	1200
398	1200	398	1200
384	1200	384	1200
371	1200	371	1200
357	1200	357	1200
343	1200	343	1200
329	1200	329	1200
315	1200	315	1200

Top Hung Casement – 12” 20kg Max Weight – Min Width 424

12mm Glazing Thickness		8mm Glazing Thickness	
Height	Width	Height	Width
590	1103	590	1200
568	1147	568	1200
546	1193	546	1200
523	1200	523	1200
501	1200	501	1200
479	1200	479	1200
457	1200	457	1200
434	1200	434	1200
412	1200	412	1200
390	1200	390	1200

Top Hung Casement – 16” 21kg Max Weight – Min Width 424

12mm Glazing Thickness		8mm Glazing Thickness	
Height	Width	Height	Width
820	834	820	1200
789	867	789	1200
758	902	758	1200
727	941	727	1200
696	983	696	1200
664	1029	664	1200
633	1079	633	1200
602	1135	602	1200
571	1197	571	1200
540	1200	540	1200

Top Hung Casement – 20” 26kg Max Weight – Min Width 424

12mm Glazing Thickness		8mm Glazing Thickness	
Height	Width	Height	Width
1140	742	1140	1114
1096	773	1096	1159
1051	805	1051	1200
1007	841	1007	1200
962	880	962	1200
918	922	918	1200
873	969	873	1200
829	1021	829	1200
784	1079	784	1200
740	1144	740	1200

Top Hung Casement – 24” 40kg Max Weight – Min Width 424

12mm Glazing Thickness		8mm Glazing Thickness	
Height	Width	Height	Width
1340	972	1340	1200
1290	1009	1290	1200
1240	1050	1240	1200
1190	1094	1190	1200
1140	1142	1140	1200
1090	1195	1090	1200
1040	1200	1040	1200
990	1200	990	1200
940	1200	940	1200
890	1200	890	1200

Side Hung Casement – 8” 18kg Max Weight – Min Width 424

12mm Glazing Thickness		8mm Glazing Thickness	
Height	Width	Height	Width
1300	440	1300	440
1300	419	1300	419
1300	398	1300	398
1300	377	1300	377
1300	356	1300	356
1300	334	1300	334
1300	313	1300	313
1300	292	1300	292
1300	271	1300	271
1300	250	1300	250

Side Hung Casement – 12” 22kg Max Weight – Min Width 424

12mm Glazing Thickness		8mm Glazing Thickness	
Height	Width	Height	Width
1119	640	1300	640
1178	608	1300	608
1244	576	1300	576
1300	544	1300	544
1300	512	1300	512
1300	479	1300	479
1300	447	1300	447
1300	415	1300	415
1300	383	1300	383
1300	351	1300	351

Side Hung Casement – 16” 24kg Max Weight – Min Width 424

12mm Glazing Thickness		8mm Glazing Thickness	
Height	Width	Height	Width
1056	740	1300	740
1103	708	1300	708
1155	676	1300	676
1212	644	1300	644
1276	612	1300	612
1300	581	1300	581
1300	549	1300	549
1300	517	1300	517
1300	485	1300	485
1300	453	1300	453

Specification Casement Windows

Top Hung Casement – 10” HD Stay 37kg Max Weight – Min Width 424

12mm Glazing Thickness		8mm Glazing Thickness	
Height	Width	Height	Width
681	1600	681	1600
640	1600	640	1600
599	1600	599	1600
558	1600	558	1600
517	1600	517	1600
477	1600	477	1600
436	1600	436	1600
395	1600	395	1600
354	1600	354	1600
313	1600	313	1600

Top Hung Casement – 12” HD Stay 45kg Max Weight – Min Width 424

12mm Glazing Thickness		8mm Glazing Thickness	
Height	Width	Height	Width
833	1600	833	1600
816	1600	816	1600
799	1600	799	1600
782	1600	782	1600
765	1600	765	1600
749	1600	749	1600
732	1600	732	1600
715	1600	715	1600
698	1600	698	1600
681	1600	681	1600

Top Hung Casement – 16” HD Stay 55kg Max Weight – Min Width 424

12mm Glazing Thickness		8mm Glazing Thickness	
Height	Width	Height	Width
1136	1576	1136	1600
1102	1600	1102	1600
1069	1600	1069	1600
1035	1600	1035	1600
1001	1600	1001	1600
968	1600	968	1600
934	1600	934	1600
900	1600	900	1600
867	1600	867	1600
833	1600	833	1600

Top Hung Casement – 22” HD Stay 75kg Max Weight – Min Width 424

12mm Glazing Thickness		8mm Glazing Thickness	
Height	Width	Height	Width
1500	1600	1500	1600
1460	1600	1460	1600
1419	1600	1419	1600
1379	1600	1379	1600
1338	1600	1338	1600
1298	1600	1298	1600
1257	1600	1257	1600
1217	1600	1217	1600
1176	1600	1176	1600
1136	1600	1136	1600

Top Hung Casement – 22” SHD Stay 100kg Max Weight – Min Width 541

12mm Glazing Thickness		8mm Glazing Thickness	
Height	Width	Height	Width
1750	1750	1750	1750
1682	1750	1682	1750
1614	1750	1614	1750
1545	1750	1545	1750
1477	1750	1477	1750
1409	1750	1409	1750
1341	1750	1341	1750
1272	1750	1272	1750
1204	1750	1204	1750
1136	1750	1136	1750

**Super Heavy
Duty Stays
DFP1250**

Side Hung Casement – 10” HD Stay 38kg Max Weight – Min Width 424

12mm Glazing Thickness		8mm Glazing Thickness	
Height	Width	Height	Width
1752	706	1829	706
1829	661	1829	661
1829	616	1829	616
1829	572	1829	572
1829	527	1829	527
1829	482	1829	482
1829	437	1829	437
1829	393	1829	393
1829	348	1829	348
1829	303	1829	303

Side Hung Casement – 16” HD Stay 47kg Max Weight – Min Width 424

12mm Glazing Thickness		8mm Glazing Thickness	
Height	Width	Height	Width
1731	884	1829	884
1819	841	1829	841
1829	798	1829	798
1829	755	1829	755
1829	712	1829	712
1829	668	1829	668
1829	625	1829	625
1829	582	1829	582
1829	539	1829	539
1829	496	1829	496

Project Consultancy

Our field based Project Consultants, working with our in-house Contracts Design and Administration team, provide UK specifiers with specialist advice concerning the correct application of products, giving guidance on Building Regulations, British Standards and other issues such as product specifications, usage, maintenance and safety. Complementary to this, our Product Support Department has an invaluable reservoir of experience on every aspect of our product range.

Specification Process

We also appreciate that the specification process is influenced by client demands to obtain best value, and to that end, we can participate in site visits, design meetings and budgetary planning. Design stages can be formalised through written specification documents (which can be supplied in either an NBS format, or your own specification layout) and supported by samples, literature and drawings for consultation or planning issues.

Partnership Approach











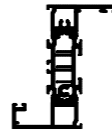
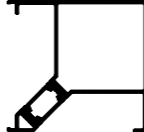

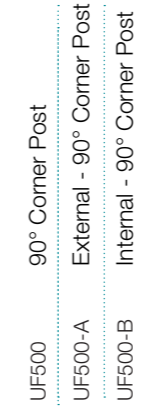

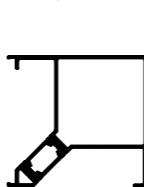
Taking this partnership approach through the whole project allows on-site monitoring of manufacturing and installation ensuring the specifier always has professional support from a worldwide group. Drawing on one of the largest fabricator and installer networks in the UK, we can provide details of specialist contractors who will quote or tender competitively for any type of contract.

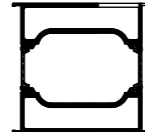
Sapa Group



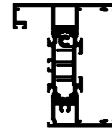

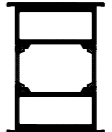
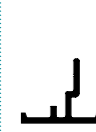





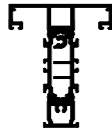

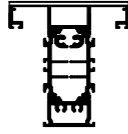

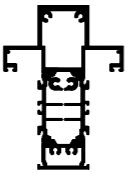
Sapa Building Systems Limited is a member of the worldwide Sapa Group. We develop and market high value-added profiles in aluminium and are the leading independent producer of aluminium profiles in the world, with customers in Europe, North America and Asia. In the UK, Sapa Group has extensive multisite extruding, re-melt, anodising and polyester powder coating facilities, offering total control and a fast and co-operative response.

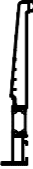
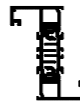
Backed by the resources of the Group, Sapa Building Systems Limited offers architects and specifiers a wide range of innovative aluminium systems for curtain walling, doors, windows and specialist applications. With a wealth of European knowledge and experience we have the product range and service that incorporates the highly respected brands that have satisfied the demands of specifiers for over four decades. Our company systems have been approved under BS EN ISO 9001:2000 and we are recognised as an Investor in People.

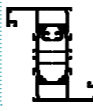
[For specification assistance or details of fabricators & installers, please call our Marketing Team on 01684 853500.](#)

Illustration	Part No.	Description	Illustration	Part No.	Description	Illustration	Part No.	Description			
Outerframe Profiles											
	DF1400	Square Outerframe		DF1408	Unequal Leg Square Outer Open Cut		UF500	90° Corner Post			
	DF1401	Square Outerframe Extended		DF1409	21mm Universal Outerframe		UF500-A	External - 90° Corner Post			
	DF1402	HD Facade Frame		DF1410	31mm Universal Outerframe		UF500-B	Internal - 90° Corner Post			
	DF1403	Facade Frame	Couplers & Misc Profiles				UF503	75mm Heavy Duty Coupler			
	DF1404	Unequal Leg Square Outerframe Open In					DF047	Reverse Rebate Adaptor		UF504	25mm Heavy Duty Coupler
	DF1407	Square Outerframe Extended Leg					DF072	25mm Coupler		UF505	50mm Heavy Duty Coupler
				DF073	Coupler		UF508	Trickle Vent Body			
				16323	Face Applied Dummy Mullion/Transom						

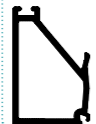
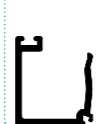
Profiles Dualframe 75mm Si Tilt Before Turn Windows

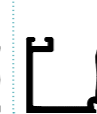
Illustration	Part No.	Description	Illustration	Part No.	Description	Illustration	Part No.	Description		
Mullion & Transom Profiles										
	DF1420	Mullion/Transom Flat 63mm	Ventframe Profiles				DF1430	TBT Vent Glaze In		
	DF1421	Wide Mullion/Transom Flat 73mm	Cill Profiles				DF703	135mm Subcill		
	DF1422	Heavy Duty Mullion/Transom 73mm		DF704	155mm Subcill		DF705	190mm Subcill		
	DF1428	63mm Reverse Mullion/Transom		DF713	100mm Subcill	Pressed Nosing Subcill				
	DF1429	73mm Reverse Mullion/Transom							DF715	Pressed Nosing Subcill
Glazing Beads										
			DF045	32mm TBT Vent Glazing Bead					DF046	32mm Outerframe Glazing Bead
			DF048	24mm TBT Vent Glazing Bead					DF049	24mm Outerframe Glazing Bead
			DF055	28mm TBT Vent Glazing Bead					DF056	28mm Outerframe Glazing Bead

Profiles Dualframe 75mm Si Casement Windows

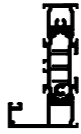





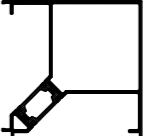

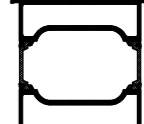

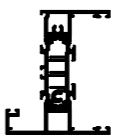







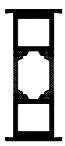
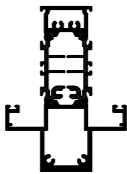

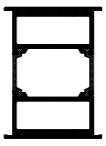



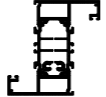

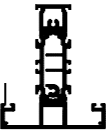

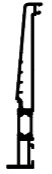
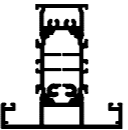



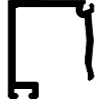

Illustration	Part No.	Description	Illustration	Part No.	Description	Illustration	Part No.	Description					
Outerframe Profiles													
	DF1400	Square Outerframe	Couplers & Misc Profiles				DF047	Reverse Rebate Adaptor					
	DF1401	Square Outerframe Extended		DF072	25mm Coupler		DF073	Coupler					
	DF1402	HD Window Wall Outerframe		16323	Face Applied Dummy Mullion/Transom				UF500	90° Corner Post			
	DF1403	Window Wall Outerframe							UF503	75mm Heavy Duty Coupler			
	DF1404	Unequal Leg Square Outerframe Open In							DF1407	Square Outerframe Extended Leg			
			DF1401	Square Outerframe Extended				DF1408	Unequal Leg Square Outerframe Open Out				
			DF1402	HD Window Wall Outerframe				DF1409	21mm Universal Outerframe				
			DF1403	Window Wall Outerframe				DF1410	31mm Universal Outerframe				
			DF1404	Unequal Leg Square Outerframe Open In									

Illustration	Part No.	Description	Illustration	Part No.	Description	Illustration	Part No.	Description
	UF504	25mm Heavy Duty Coupler		DF1422	Heavy Duty Mullion/Transom 73mm		DF1413	Heavy Duty Square Vent Open Out Glaze In
	UF505	50mm Heavy Duty Coupler		DF1428	63mm Reverse Mullion/Transom		DF703	135mm Subcill
	UF508	Trickle Vent Body		DF1429	73mm Reverse Mullion/Transom		DF704	155mm Subcill
Mullion & Transom Profiles								
	DF1420	Mullion/Transom Flat 63mm		DF1412	Square Vent Open Out Glaze In		DF705	190mm Subcill
	DF1421	Wide Mullion/Transom Flat 73mm					DF713	100mm Subcill

Cill Profiles

Ventframe Profiles

Illustration	Part No.	Description
	DF715	Pressed Nosing Subcill
Glazing Beads		
	DF046	32mm Outerframe Glazing Bead
	DF049	24mm Outerframe Glazing Bead
	DF056	28mm Outerframe Glazing Bead





















Profile Inertia Values Dualframe 75mm Si Tilt Before Turn Windows

This page gives information on the inertia values of the framing profiles calculated in accordance with :- BS EN 14024 : 2004.

BS6399 Part 2 must be used to calculate the inertia value required.

The table gives inertia values for varying spans of profile. Select the nearest span BELOW the actual span and use the value shown to compare against the inertia required.

Values shown are mm⁴

Profile	Inertia	Span													Inertia
		750mm	900mm	1050mm	1200mm	1350mm	1500mm	1650mm	1800mm	1950mm	2100mm	2250mm	2400mm		
 DF1400	↔	99,876	122,644	143,205	161,067	176,619	189,857	201,167	210,827	218,885	225,635	231,585	237,004	↕	39,639
 DF1401	↔	109,752	136,620	161,614	184,543	204,662	222,288	237,636	250,996	262,565	272,528	281,347	288,722	↕	76,085
 DF1402	↔	372,582	425,738	477,044	525,018	568,712	607,925	642,630	673,347	700,469	724,208	744,961	763,225	↕	46,900
 DF1403	↔	352,133	401,598	447,760	489,421	526,228	558,370	586,237	610,385	631,115	649,187	664,797	678,323	↕	24,142
 DF1404	↔	107,462	132,701	155,676	176,129	193,968	209,095	222,336	233,607	243,240	251,638	258,596	264,628	↕	77,372
 DF1407	↔	121,175	151,313	179,661	205,304	228,215	248,605	266,147	281,135	294,296	305,967	315,639	324,696	↕	95,651
 DF1408	↔	112,772	140,038	165,100	187,619	207,591	224,861	239,545	252,501	263,289	273,090	281,061	288,428	↕	57,828
 DF1409	↔	88,496	107,522	124,340	138,754	150,944	161,224	169,700	176,739	182,805	187,966	192,379	196,278	↕	8,881
 DF1410	↔	100,379	124,329	146,517	166,173	183,681	198,670	211,462	222,807	232,338	240,653	247,833	253,620	↕	30,276
 DF1420	↔	112,295	138,943	163,484	185,230	204,328	220,978	235,093	247,120	257,838	266,736	274,310	280,788	↕	103,317
 DF1421	↔	116,587	145,890	173,799	199,416	222,541	242,954	260,811	276,535	290,639	302,319	312,881	321,988	↕	163,046
 DF1422	↔	253,294	298,547	342,725	384,216	422,338	456,789	487,544	514,837	538,836	560,157	578,946	595,624	↕	193,190
 DF1428	↔	112,420	139,741	165,116	187,932	207,918	225,614	240,904	253,805	264,985	274,761	283,219	290,586	↕	70,397
 DF1429	↔	119,536	149,652	178,104	204,398	228,175	248,995	267,380	283,482	297,830	310,092	320,653	330,213	↕	121,893
 DF1430	↔	148,741	180,606	210,834	238,445	263,053	284,839	304,024	320,436	335,054	347,689	358,624	368,067	↕	82,455
 DF072	↔													↕	36,058
 UF500	↔													↕	Previous
 UF503	↔													↕	668,973
 UF504	↔													↕	43,773
 UF505	↔													↕	261,434





















Profile Inertia Values Dualframe 75mm Si Casement Windows

This page gives information on the inertia values of the framing profiles calculated in accordance with :- BS EN 14024 : 2004.

BS6399 Part 2 must be used to calculate the inertia value required.

The table gives inertia values for varying spans of profile. Select the nearest span BELOW the actual span and use the value shown to compare against the inertia required.

Values shown are mm⁴

Profile	Inertia	Span													Inertia
		750mm	900mm	1050mm	1200mm	1350mm	1500mm	1650mm	1800mm	1950mm	2100mm	2250mm	2400mm		
 DF1400	↔	99,876	122,665	143,205	161,067	176,619	189,857	201,167	210,827	218,885	225,635	231,586	237,004	↕	39,639
 DF1401	↔	109,752	136,620	161,614	184,543	204,662	222,288	237,636	250,996	262,565	272,528	281,347	288,722	↕	76,085
 DF1402	↔	372,582	425,738	477,044	525,018	568,712	607,925	642,630	673,347	700,469	724,208	744,961	763,225	↕	49,900
 DF1403	↔	352,133	401,598	447,760	489,421	526,228	558,370	586,237	610,385	631,115	649,187	664,797	678,323	↕	24,142
 DF1404	↔	107,462	132,701	155,676	176,129	193,968	209,095	222,336	233,607	243,240	251,538	258,596	264,628	↕	77,372
 DF1407	↔	121,175	151,313	179,661	205,304	228,215	248,605	266,147	281,135	294,296	305,967	315,639	324,696	↕	95,561
 DF1408	↔	112,772	140,038	165,100	187,619	207,591	224,861	239,545	252,501	263,289	273,090	281,061	288,428	↕	57,828
 DF1409	↔	88,496	107,522	124,340	138,754	150,944	161,224	169,700	176,739	182,805	187,966	192,379	196,278	↕	8,881
 DF1410	↔	100,379	124,329	146,517	166,173	183,681	198,670	211,462	222,807	232,338	240,653	247,833	253,620	↕	30,276
 DF1412	↔	83,425	102,880	120,796	136,663	150,682	162,657	173,026	181,846					↕	85,981
 DF1413	↔	85,545	105,038	123,087	139,138	153,253	165,379	175,863	184,810					↕	99,983
 DF1420	↔	112,295	138,943	163,484	185,230	204,328	220,978	235,093	247,120	257,838	266,736	274,310	280,788	↕	103,317
 DF1421	↔	116,587	145,890	173,799	199,416	222,541	242,954	260,811	276,535	290,639	302,319	312,881	321,988	↕	163,046
 DF1422	↔	253,294	298,547	342,725	384,216	422,338	456,789	487,544	514,837	538,836	560,157	578,946	595,624	↕	193,190
 DF1428	↔	112,420	139,741	165,116	187,932	207,918	225,614	240,904	253,805	264,985	274,761	283,219	290,586	↕	70,397
 DF1429	↔	119,536	149,652	178,104	204,398	228,175	248,995	267,380	283,482	297,830	310,092	320,653	330,213	↕	121,893
 DF072	↔													↕	36,058
 UF500	↔													↕	Previous
 UF503	↔													↕	668,873
 UF504	↔													↕	43,773
 UF505	↔													↕	261,434

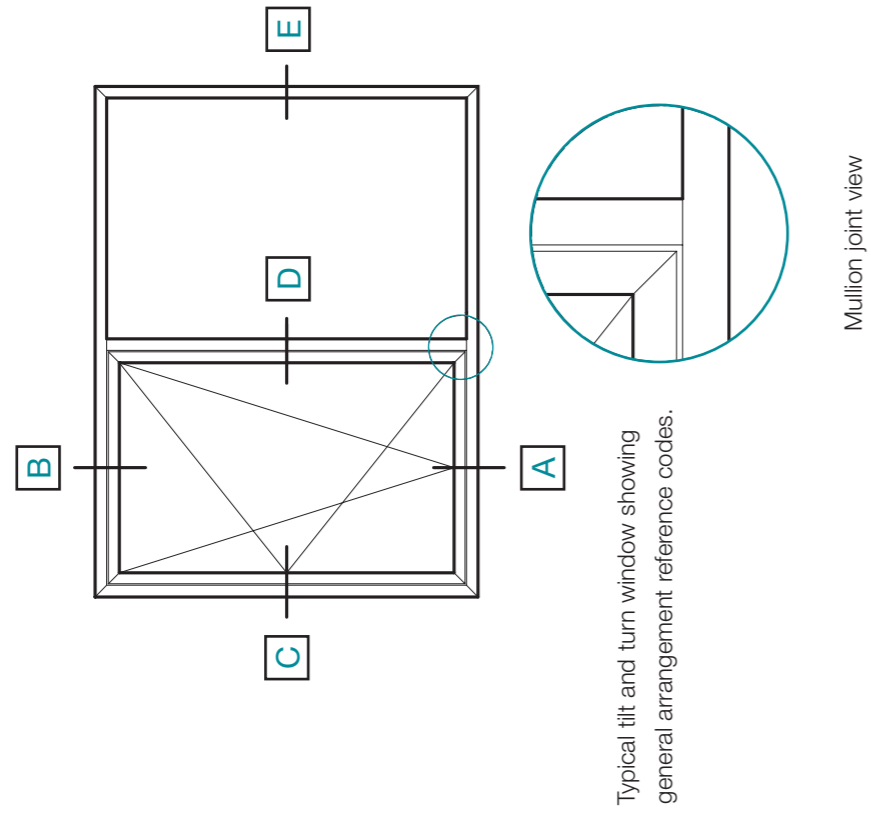

A Cill

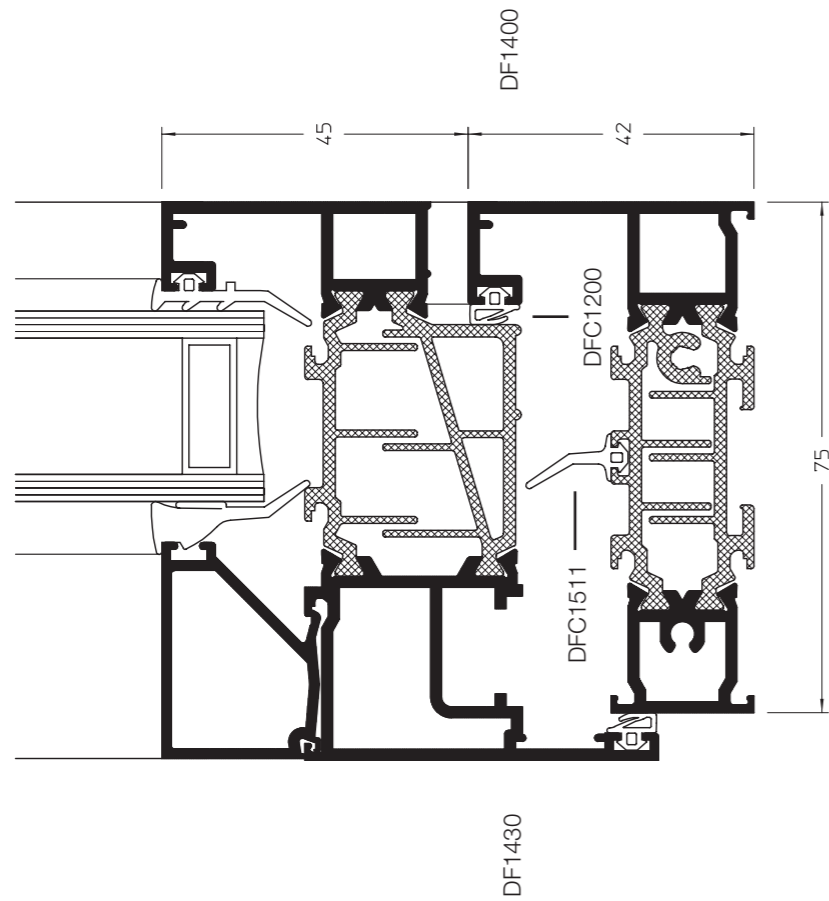

A Cill

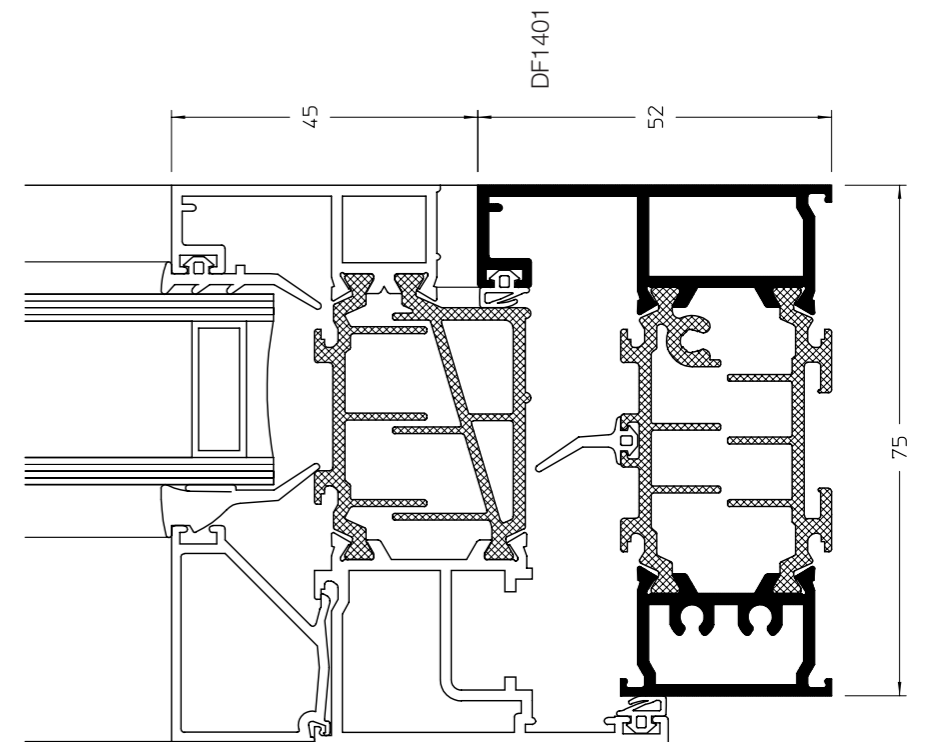

A Cill

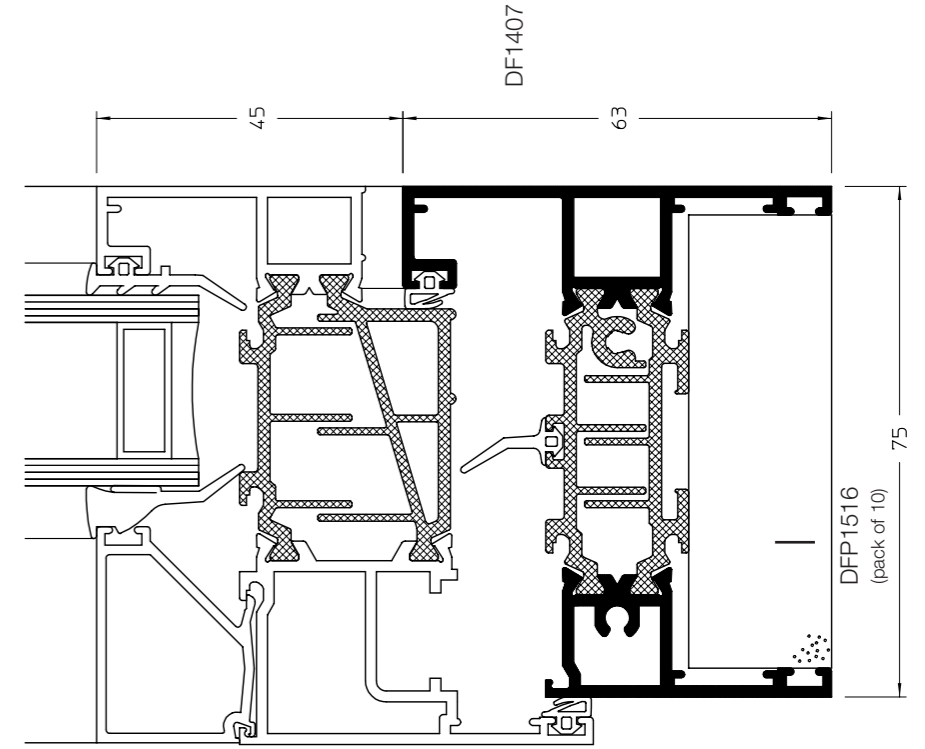

A Cill

Showing alternative unequal leg outerframe.

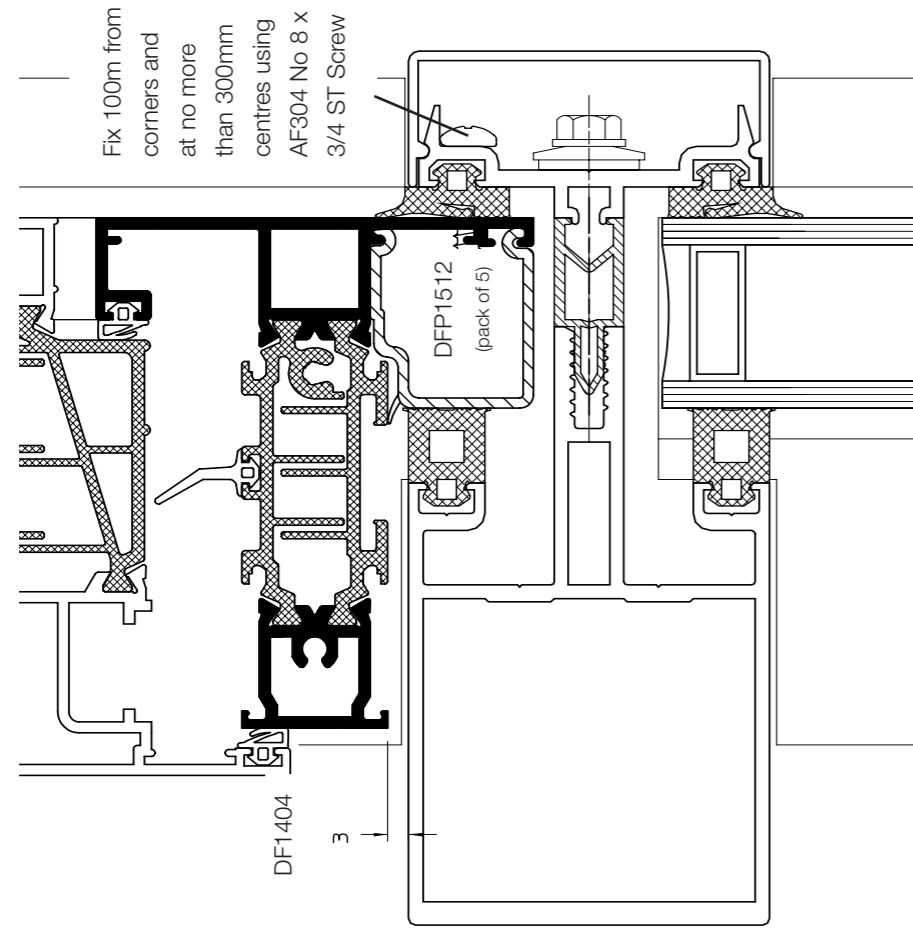

A Cill

Showing alternative unequal leg outerframe.

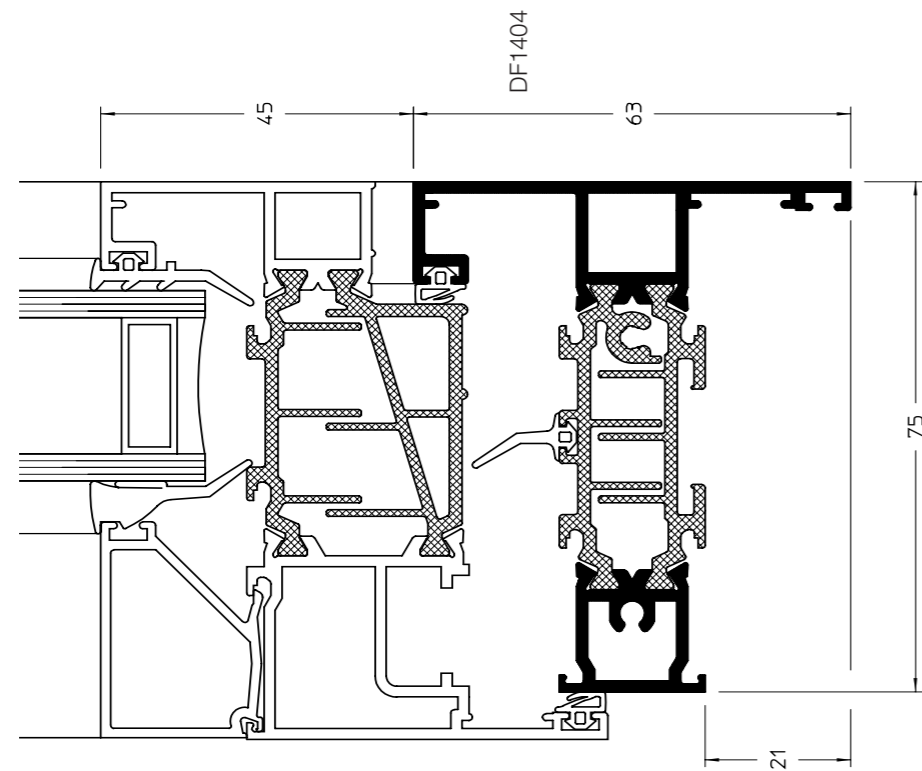

C Opening Light Jamb

Opening Light Jamb

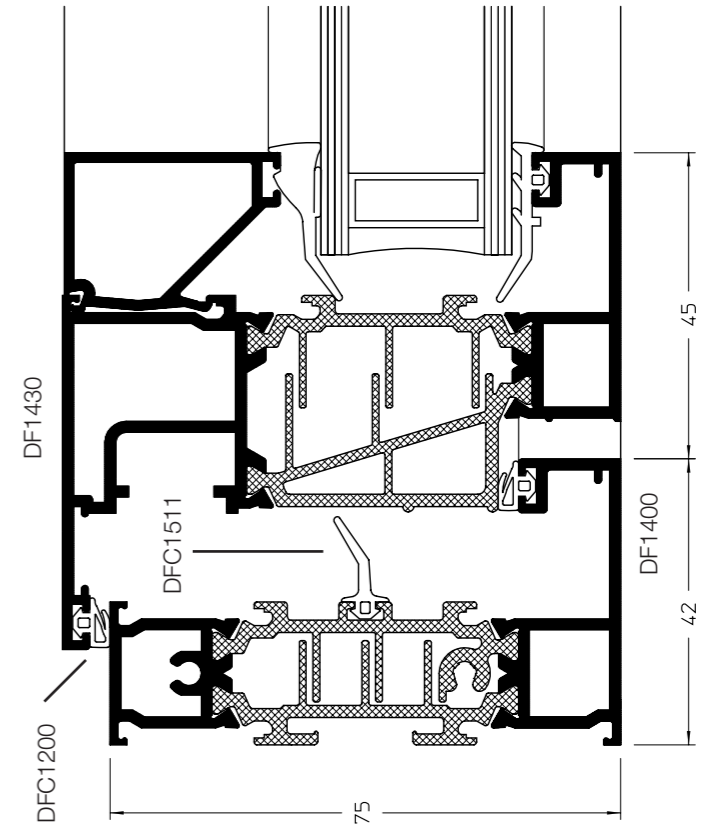

B Head

Head

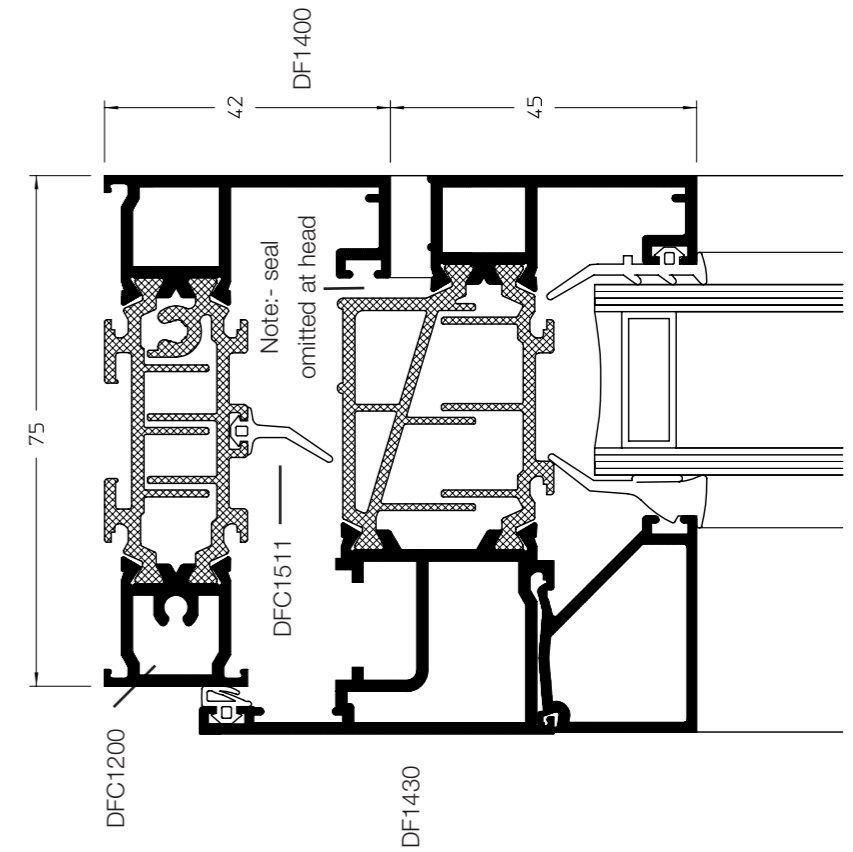

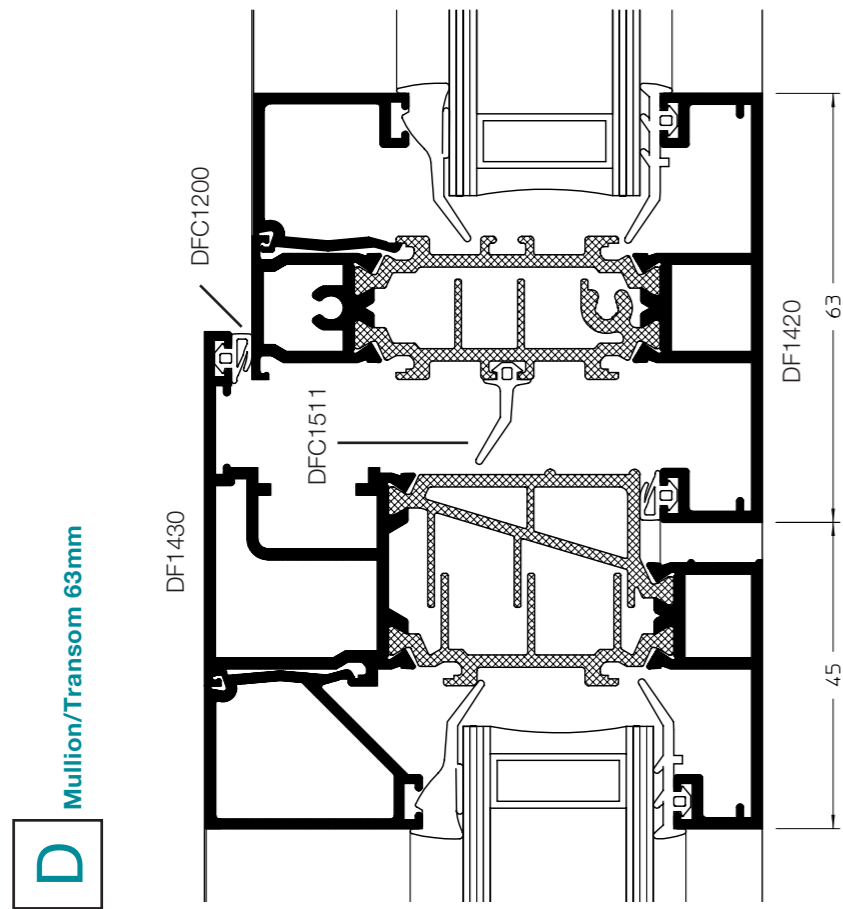
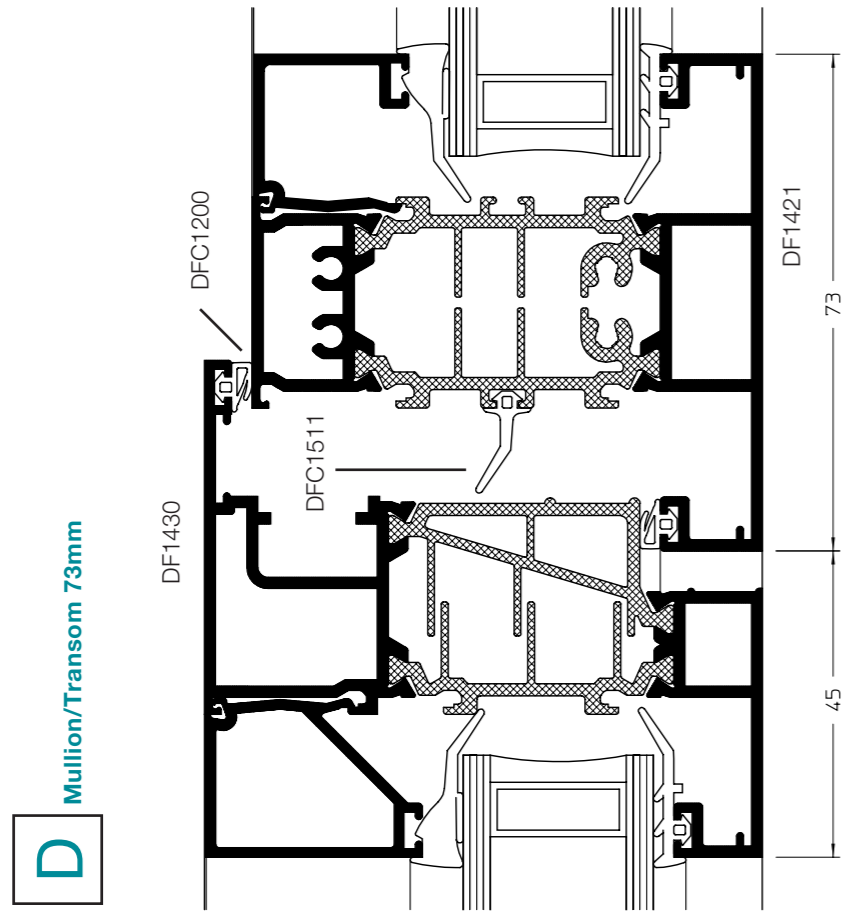

E Fixed Light Jamb

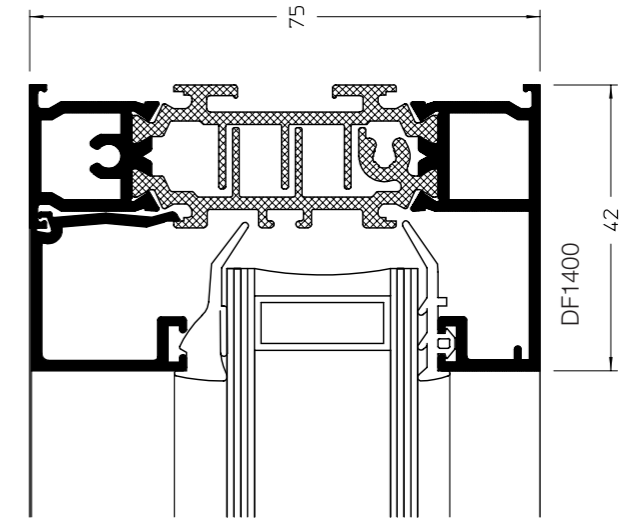

D Heavy Duty Mullion/Transom 73mm

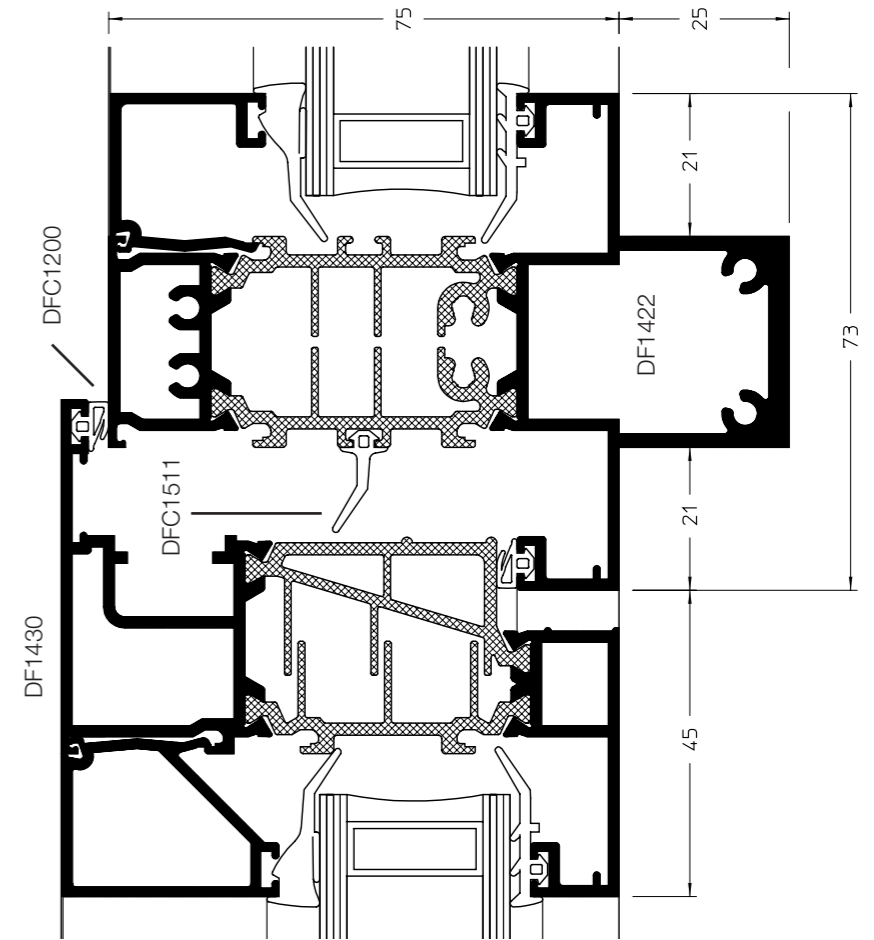

Subcills

Showing alternative subcills. Note:- DF1407 cannot be used with DF715

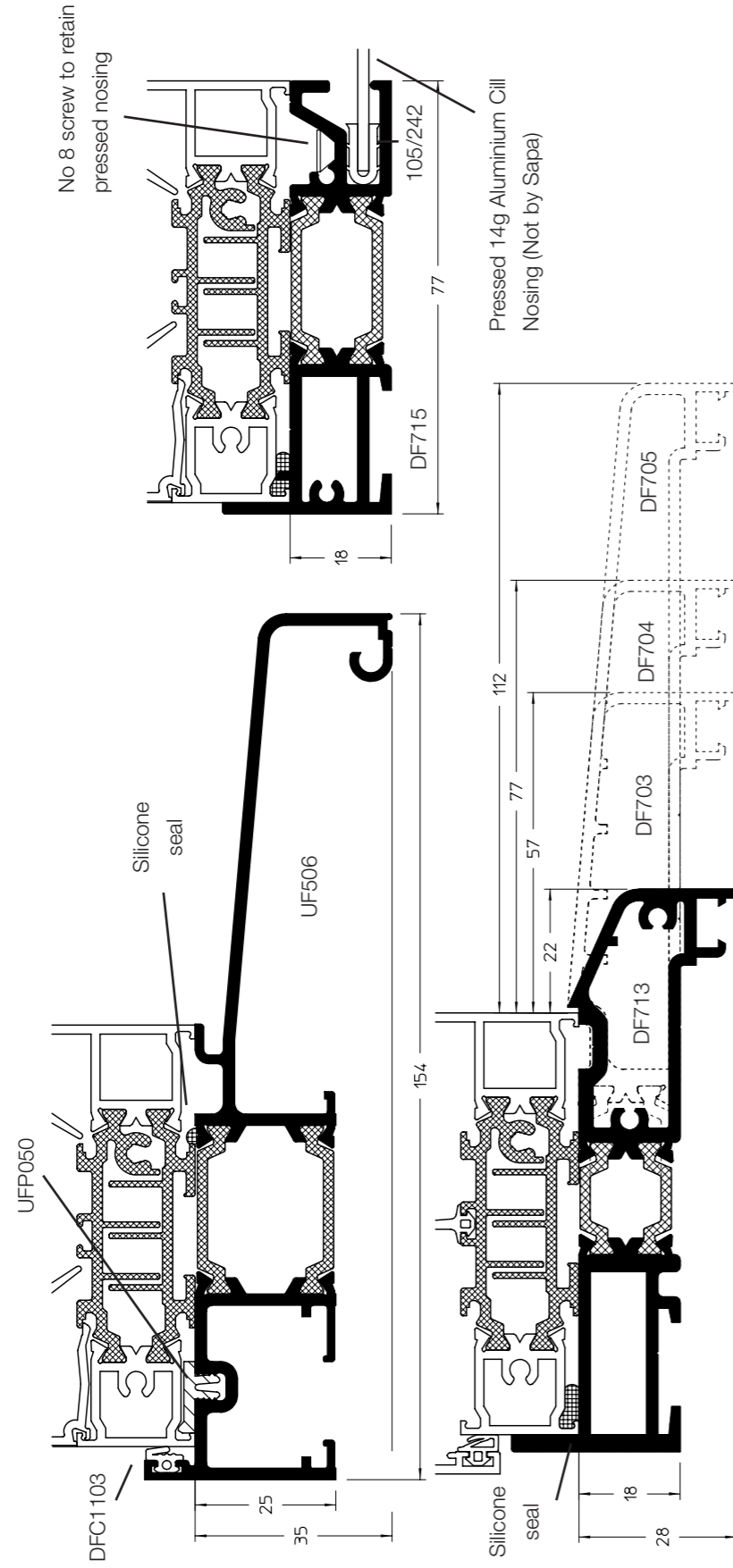

Light Weight Coupler

25mm Coupler

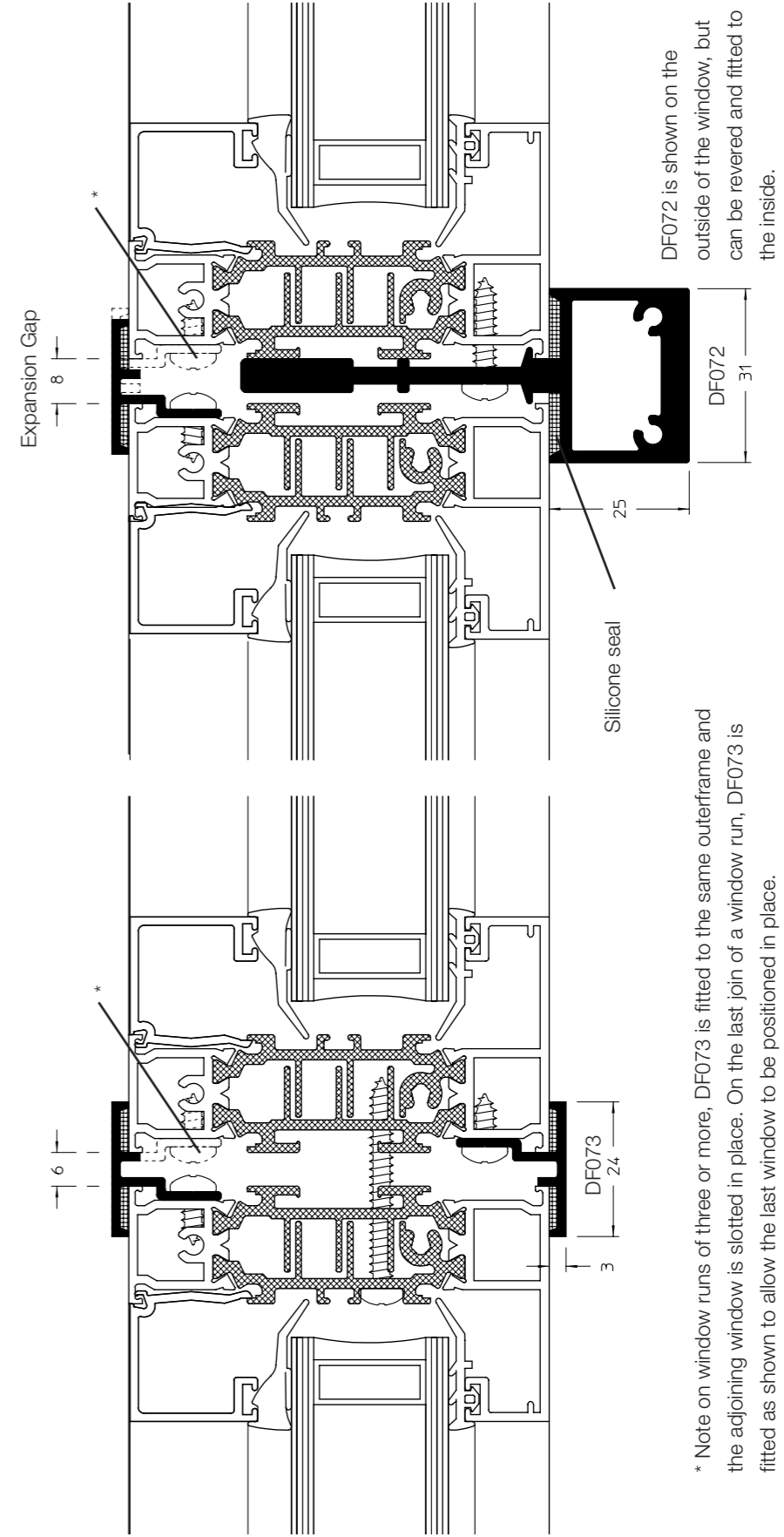

* Note on window runs of three or more, DF073 is fitted to the same outerframe and the adjoining window is slotted in place. On the last join of a window run, DF073 is fitted as shown to allow the last window to be positioned in place.

90° Corner Post

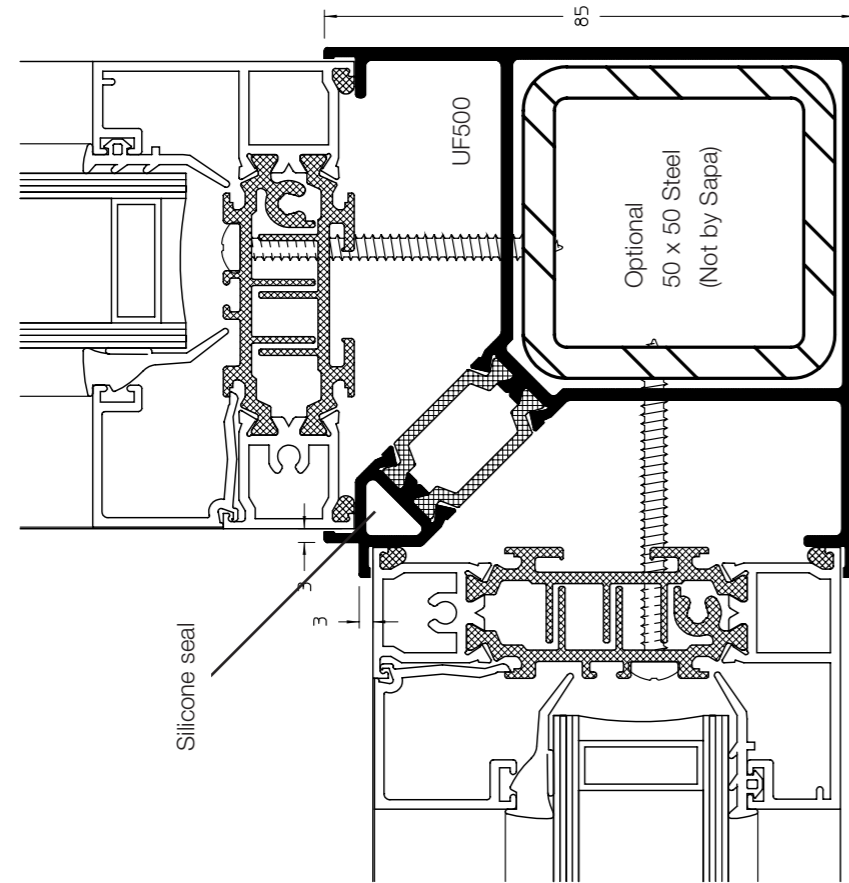

Flush Coupler

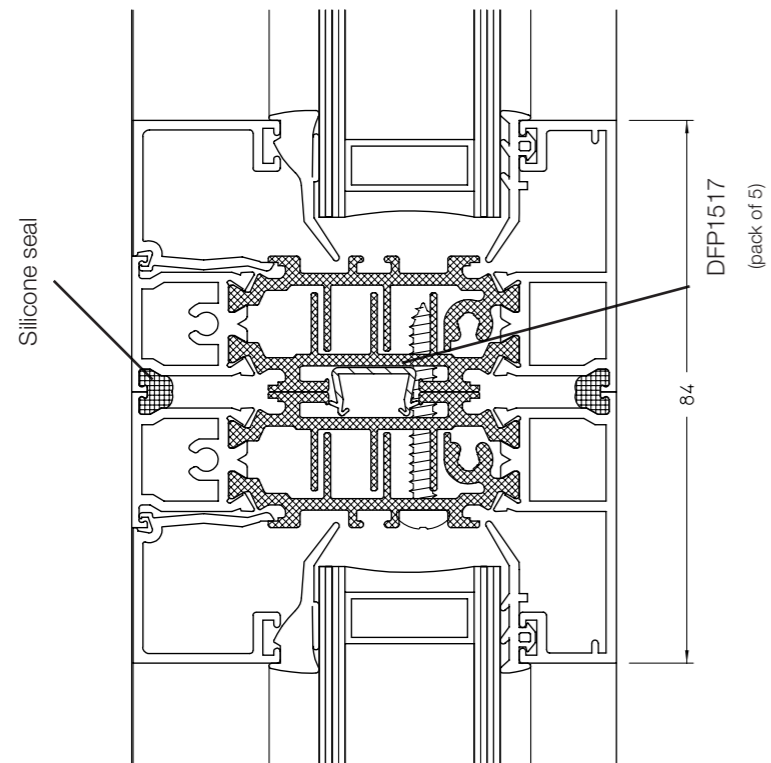

Showing outerframe DF1400.
This option is also available for DF1401 outerframe

25mm Heavy Duty Coupler

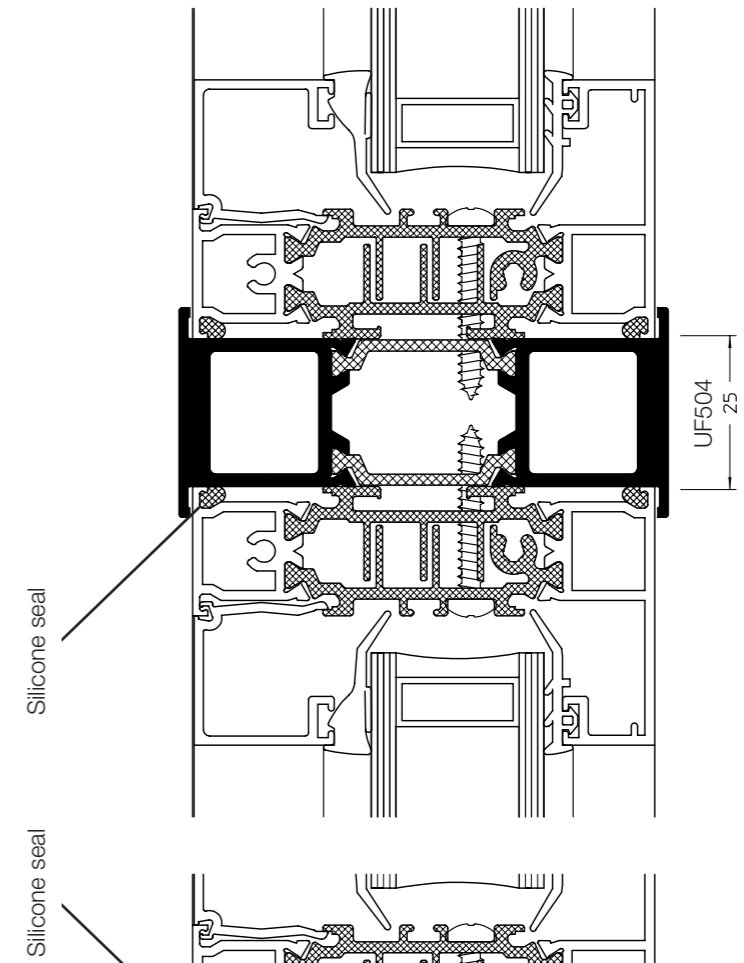

75mm Heavy Duty Coupler

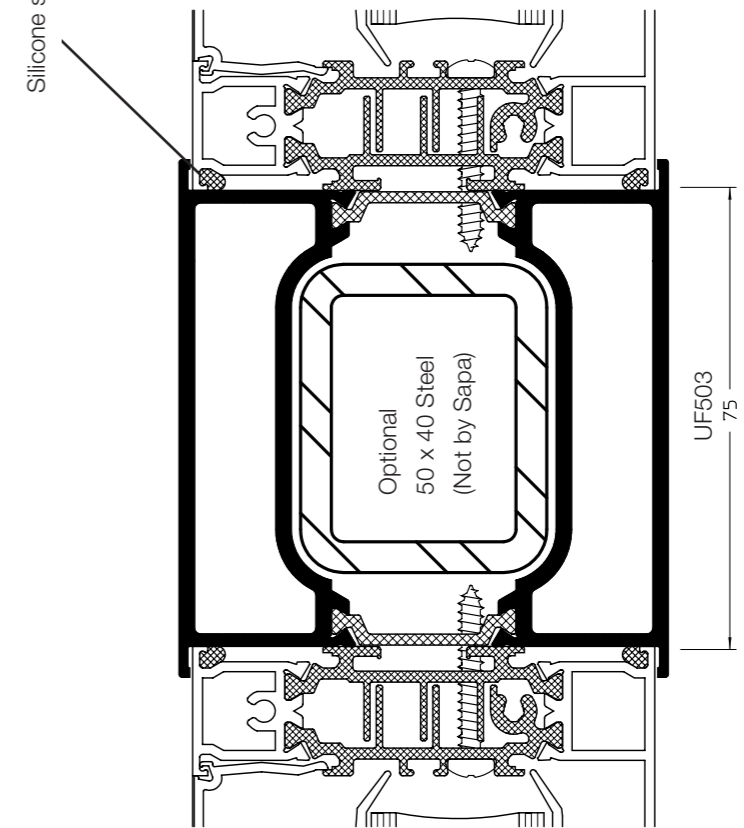

50mm Heavy Duty Coupler

Showing Dualframe 75mm Si Coupled to Dualframe 75mm

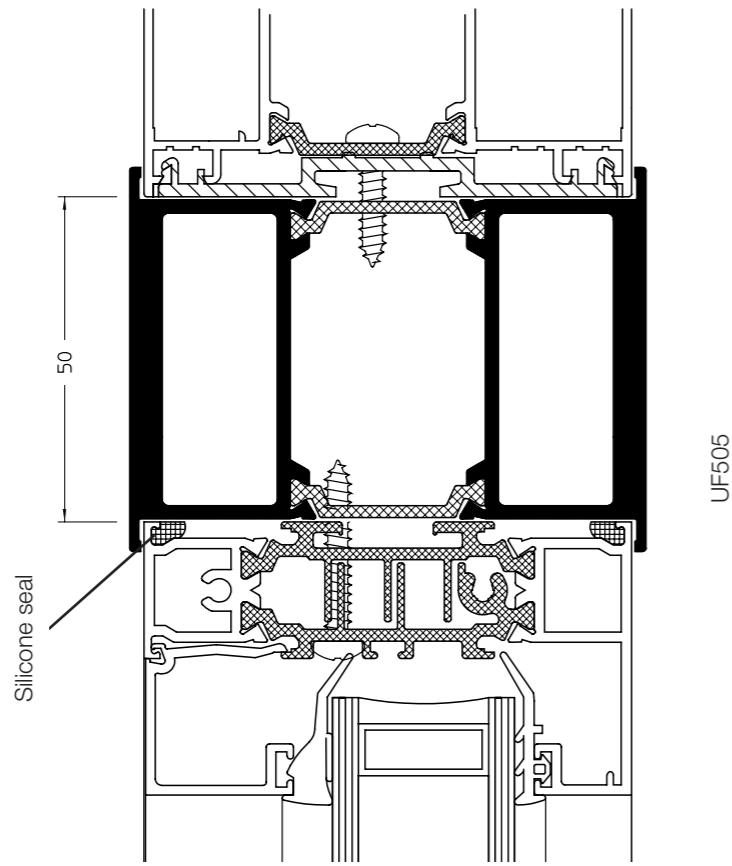

Face Applied Dummy Mullion/Transom

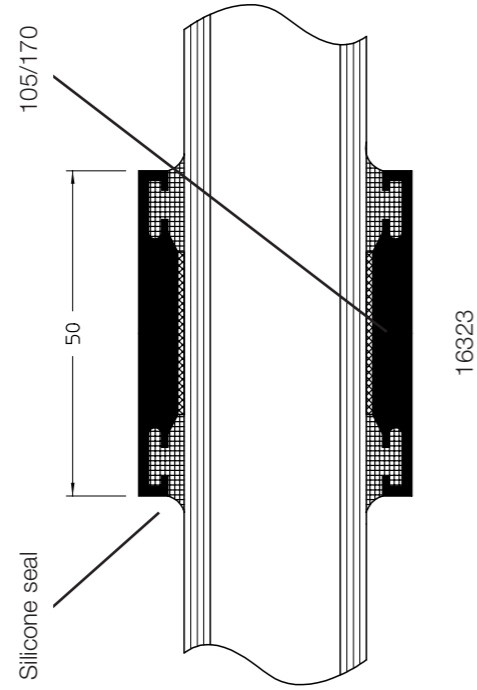

Reverse Rebate Mullion

Showing outerframe DF1400.
This option is also available for DF1401 outerframe

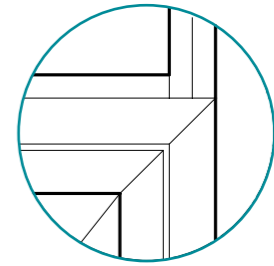
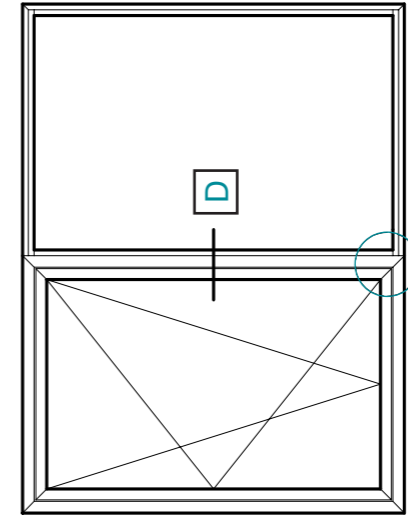
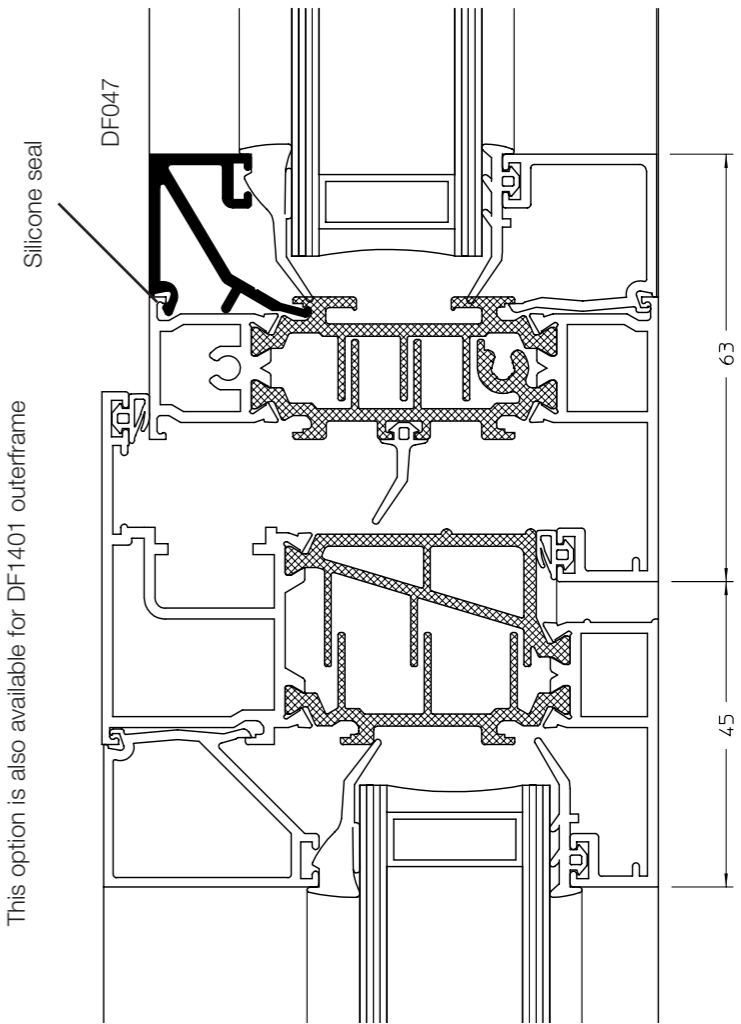

Typical tilt and turn window.

Please note that the reverse rebate adaptor can only be used in fixed lights, next to a TBT window. e.g. By the side or above/below.

The rebate adaptor can not be used in cruciform configurations.

Mullion joint view

Head Vent Body

Showing optional trickle vent profile, DF1400 frame shown, other frame / vent profile combinations available.

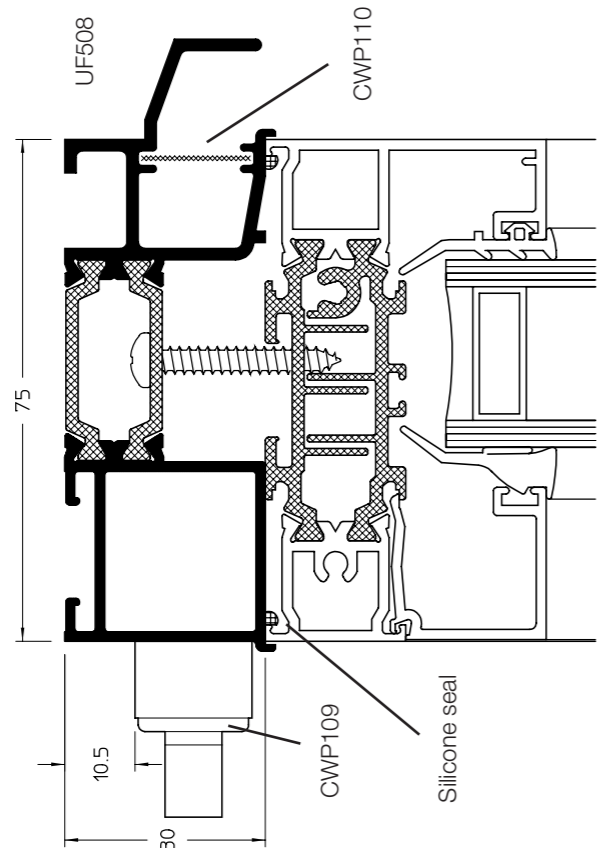

Head Vent

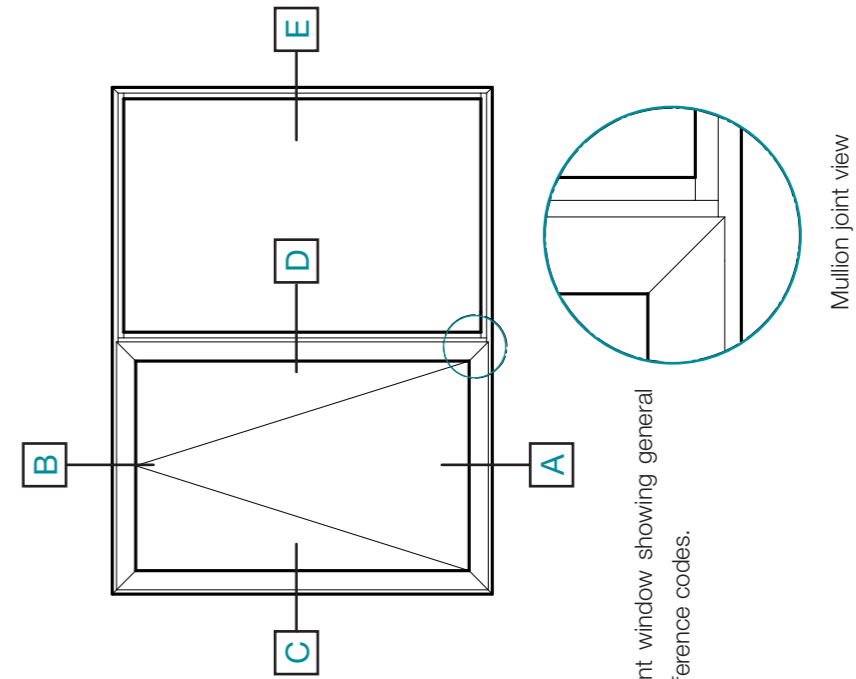
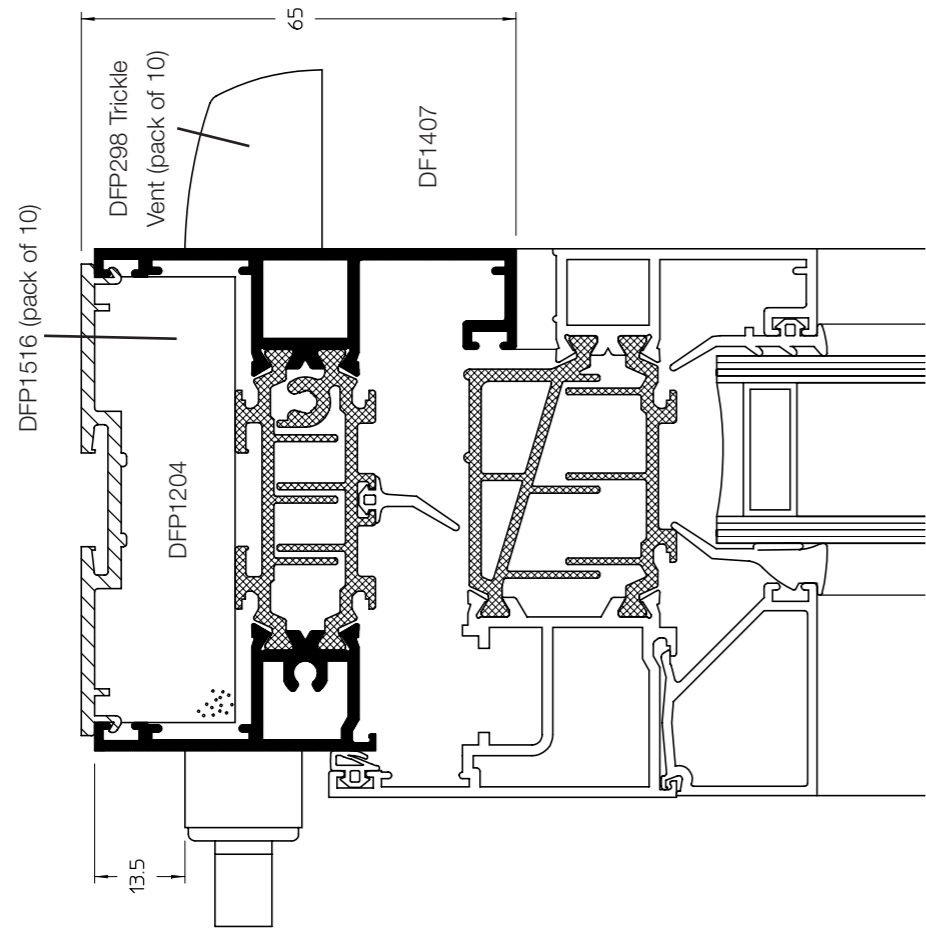

Typical casement window showing general arrangement reference codes.

A Cill

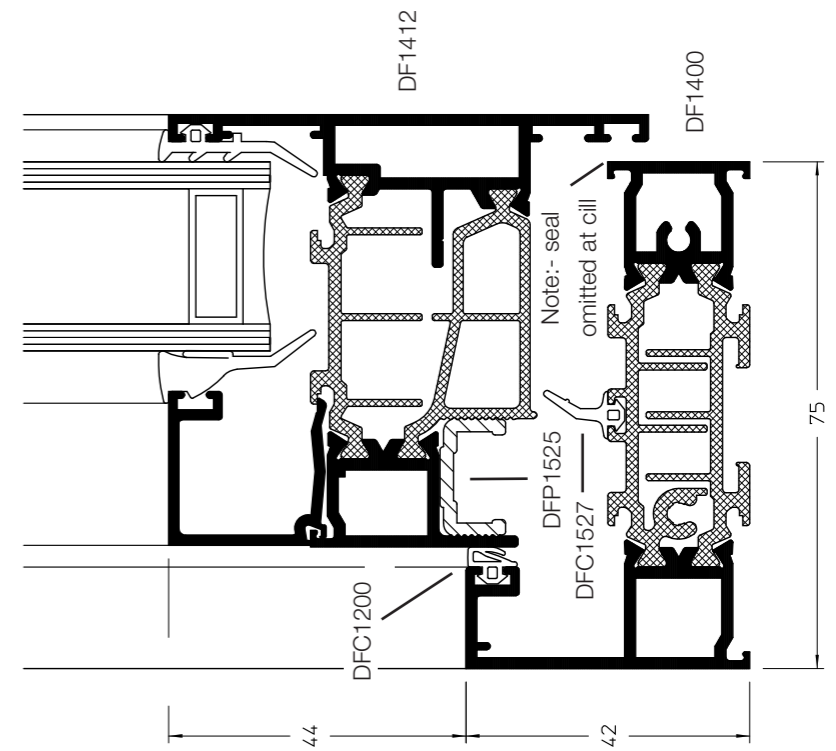

A cill

Showing alternative heavy duty ventframe.

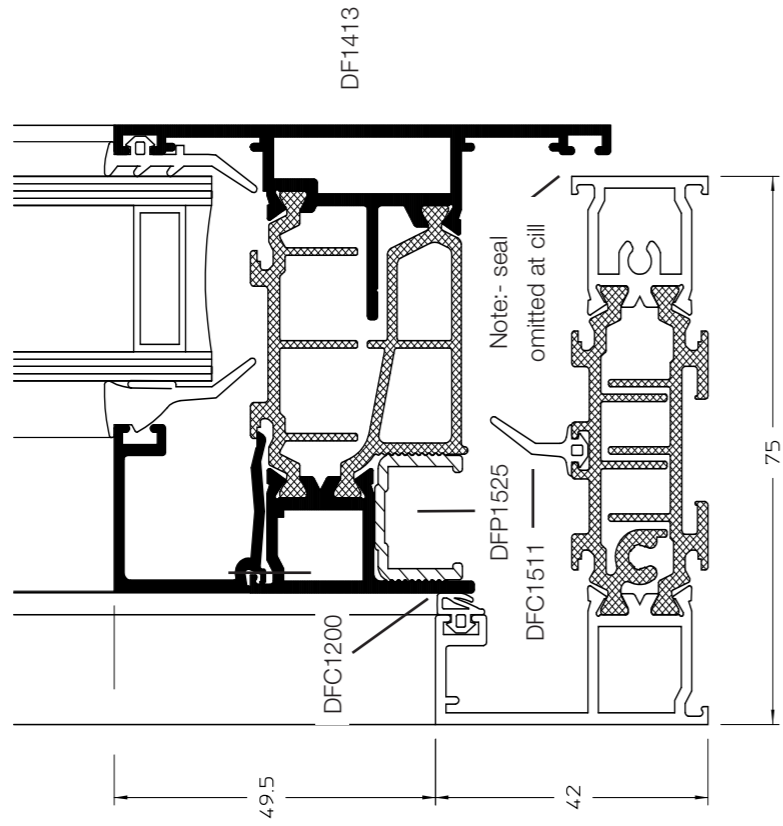

A cill

Showing alternative extended outerframe.

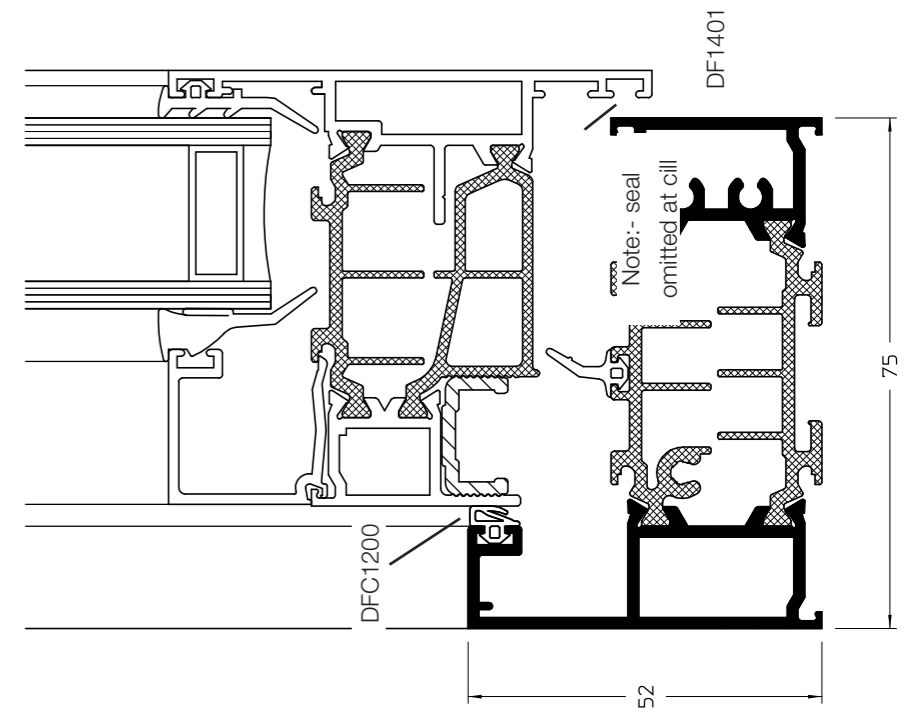

A cill

Showing alternative extended leg outerframe.

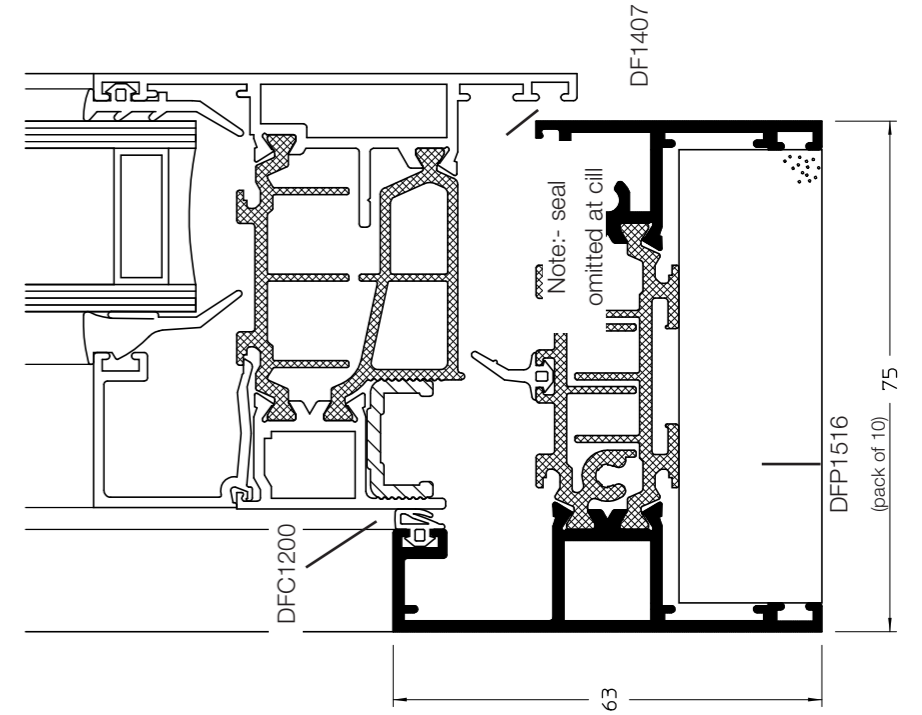

A Cill

Showing alternative unequal leg outerframe.

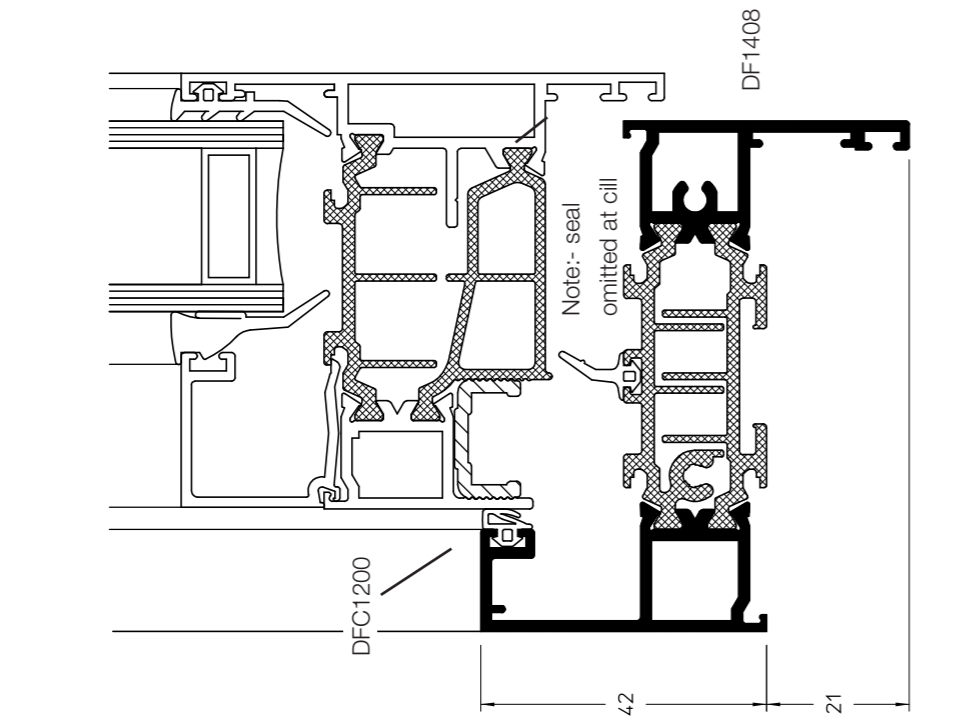

A Cill

Showing alternative curtain wall outerframe.

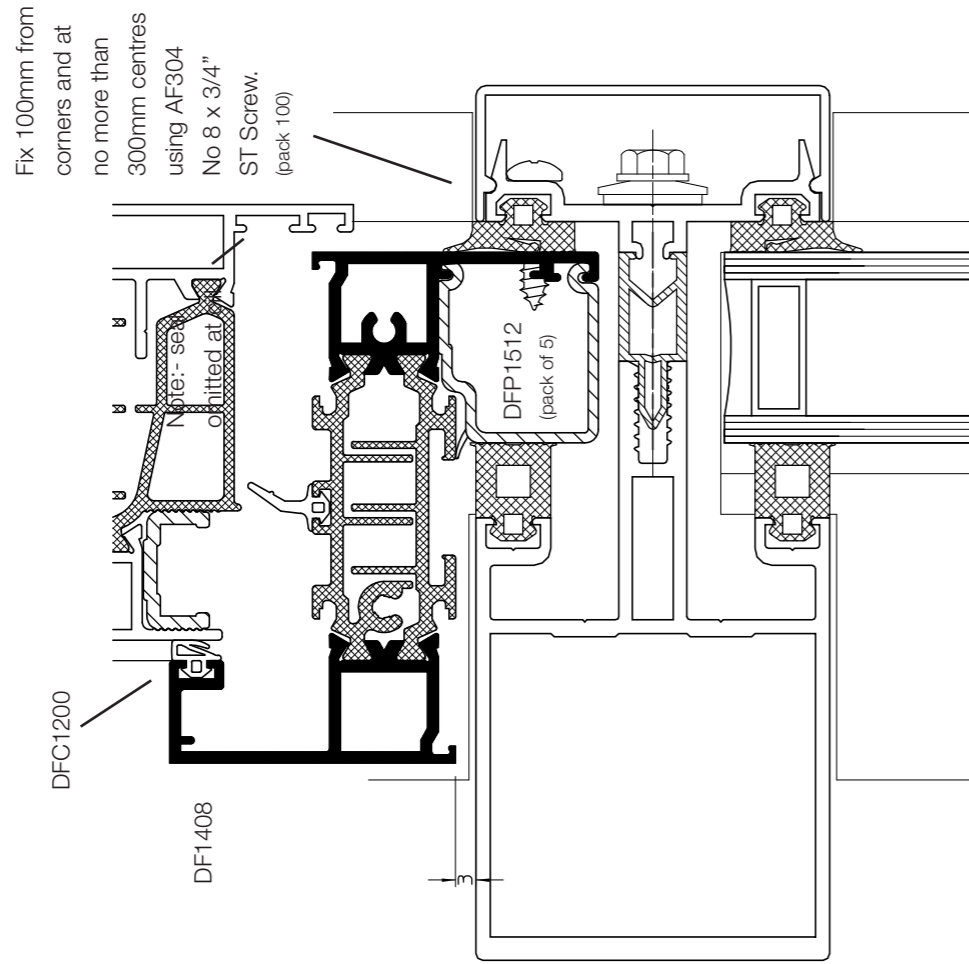

B Head

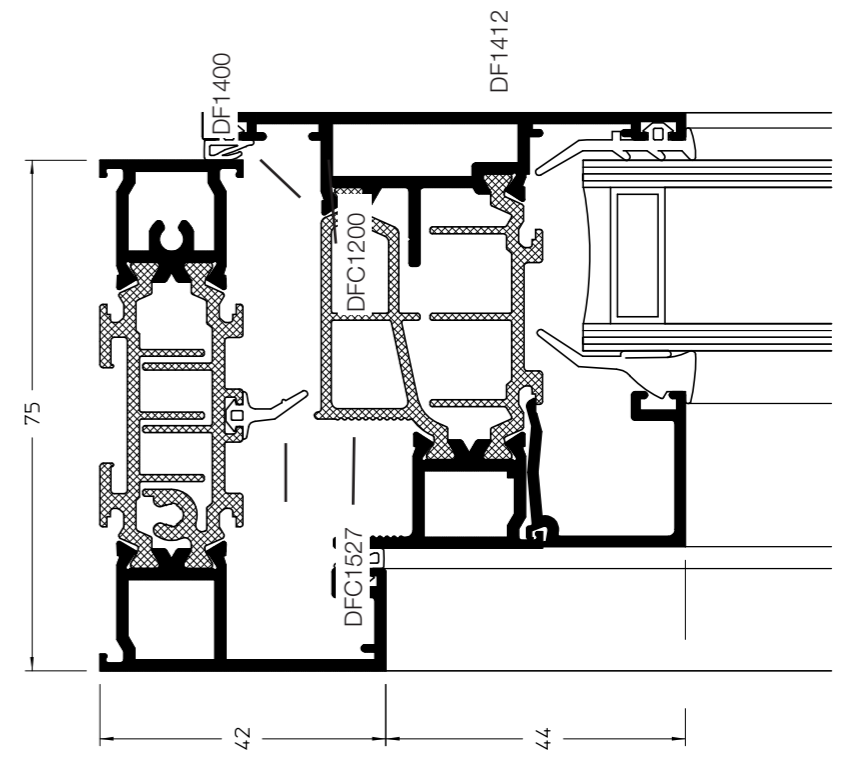

C Opening Light Jamb

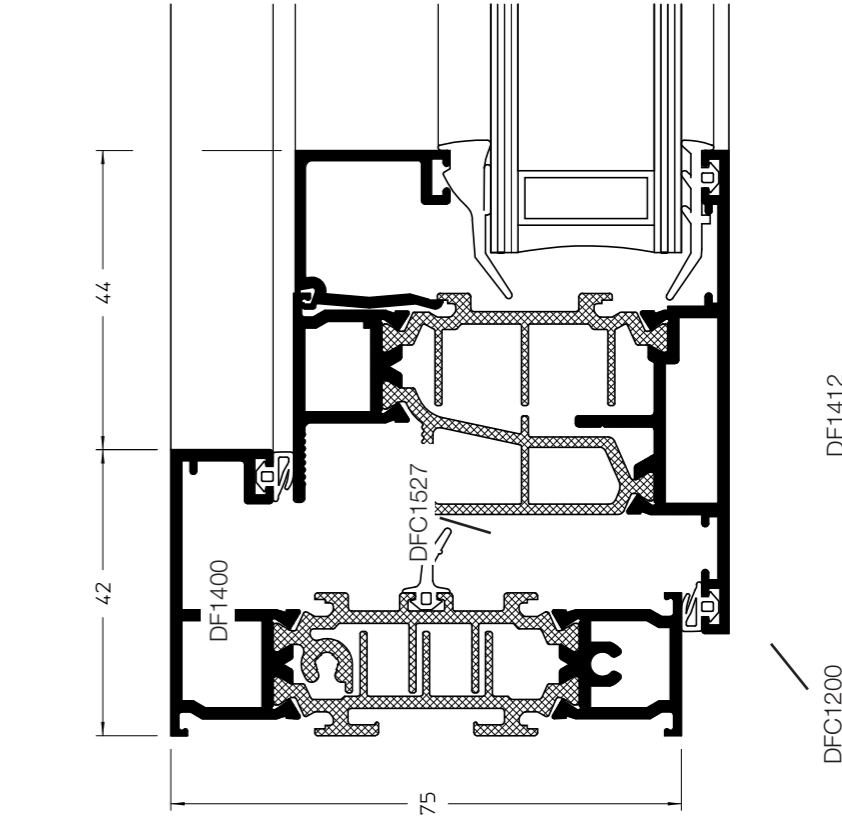

D Mullion/Transom 73mm

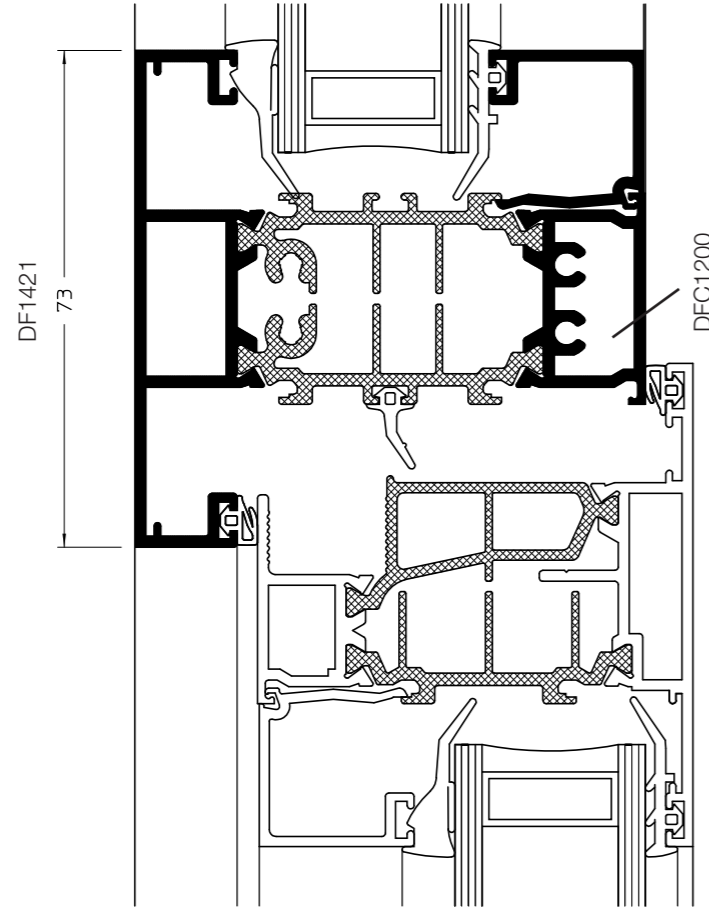

D Mullion/Transom 63mm

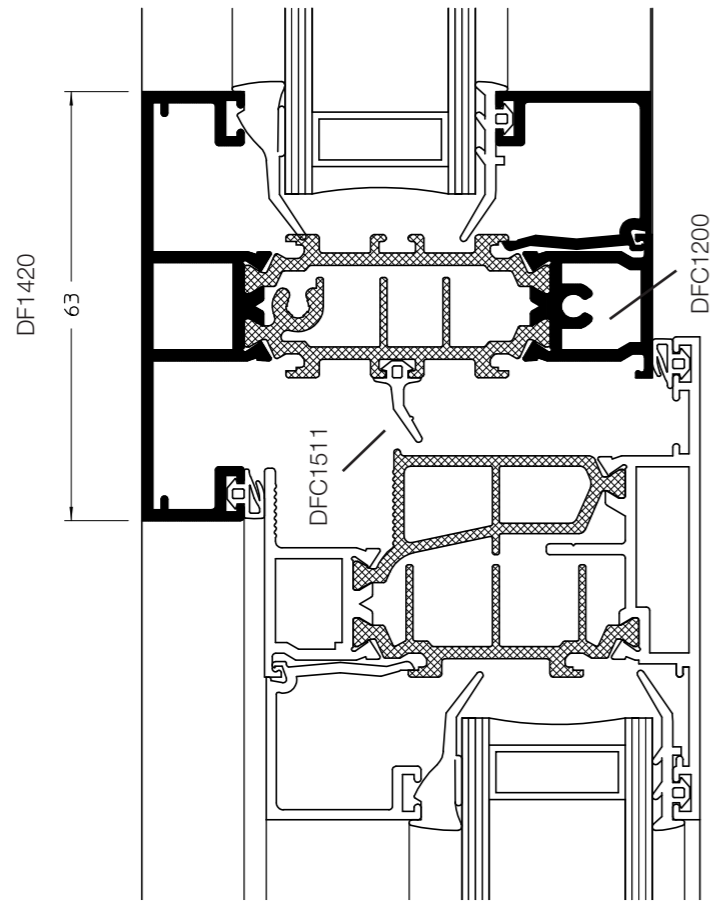

E Fixed Light Jamb

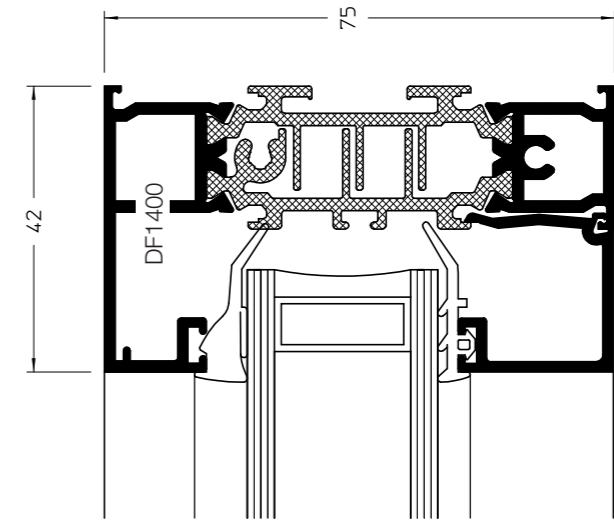

D Heavy Duty Mullion/Transom 73mm

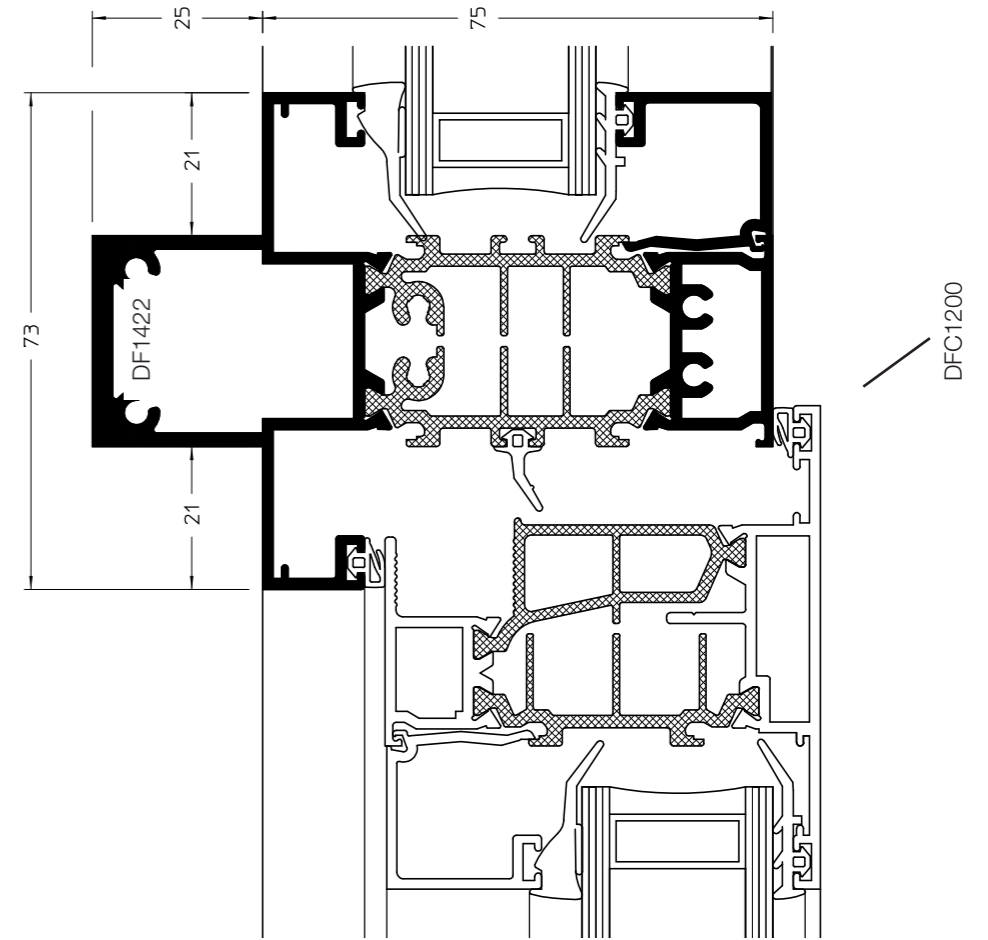

Subcills

Showing alternative subcills

Note:- DF1407 cannot be used with DF715.

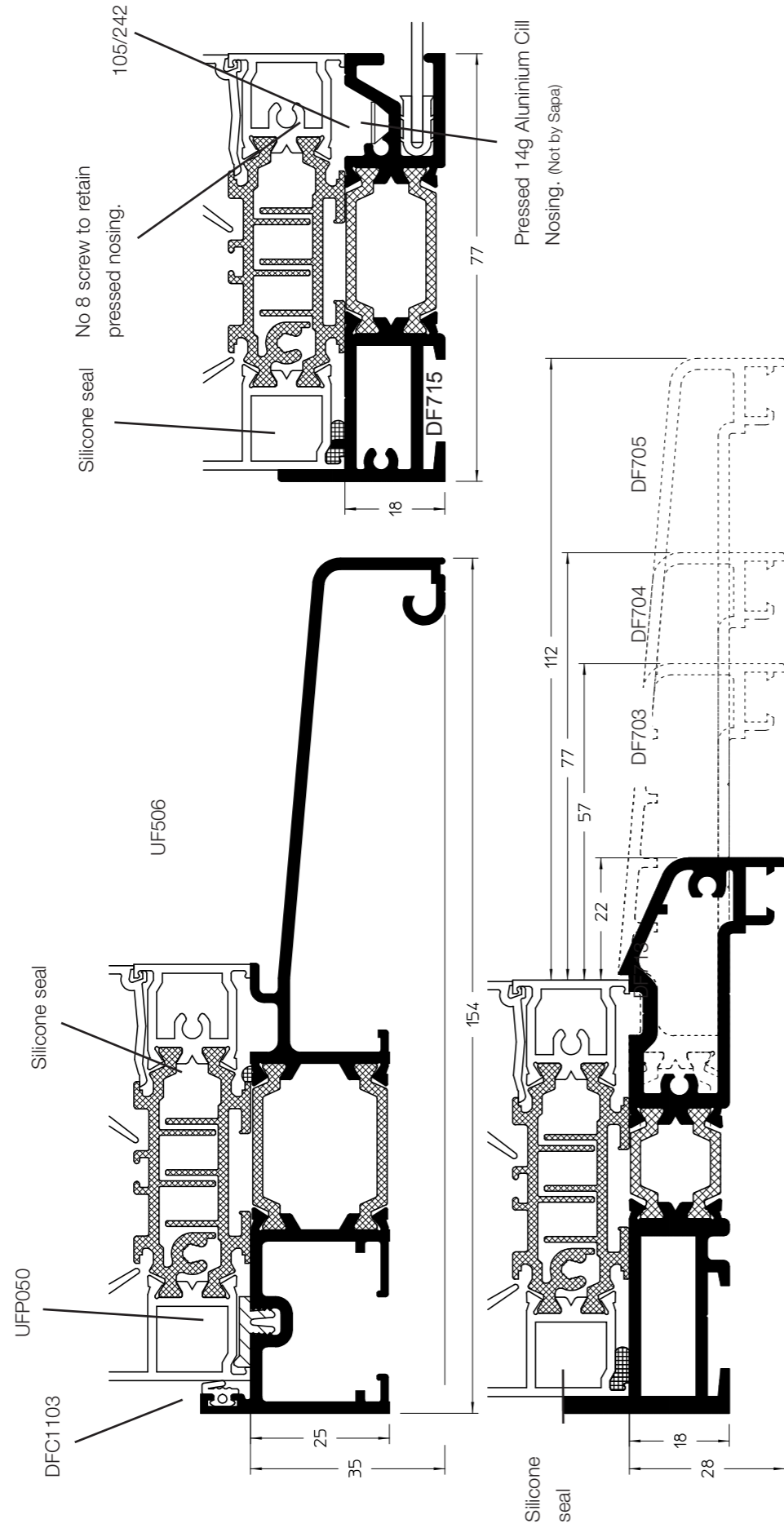

Light Weight Coupler

25mm Coupler

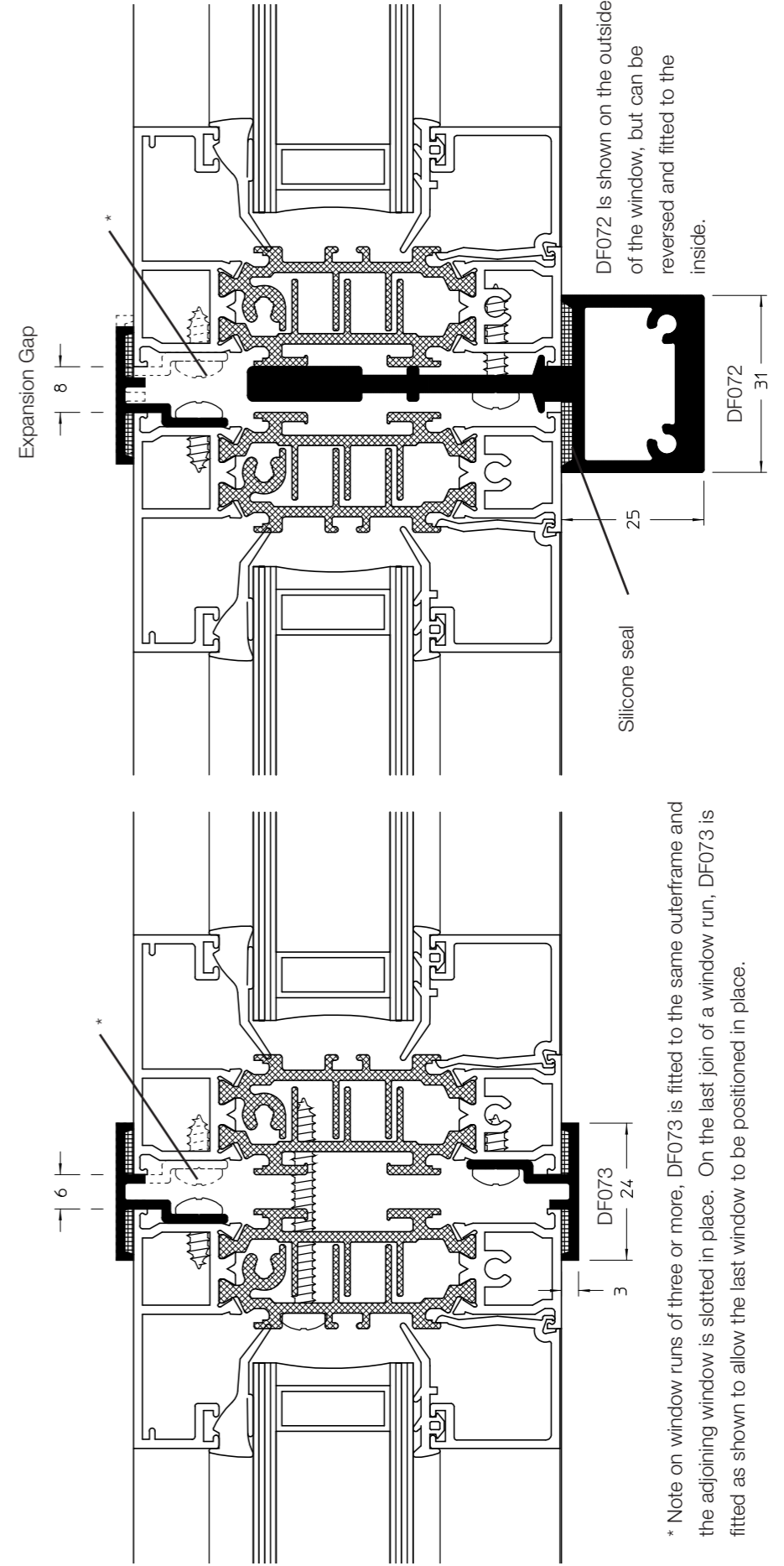

* Note on window runs of three or more, DF073 is fitted to the same outerframe and the adjoining window is slotted in place. On the last join of a window run, DF073 is fitted as shown to allow the last window to be positioned in place.

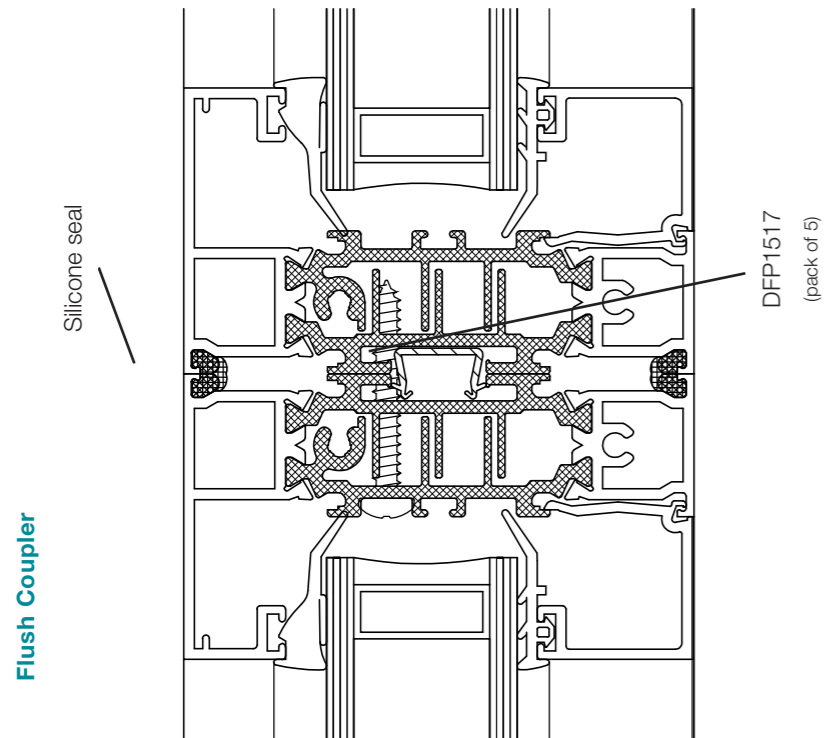
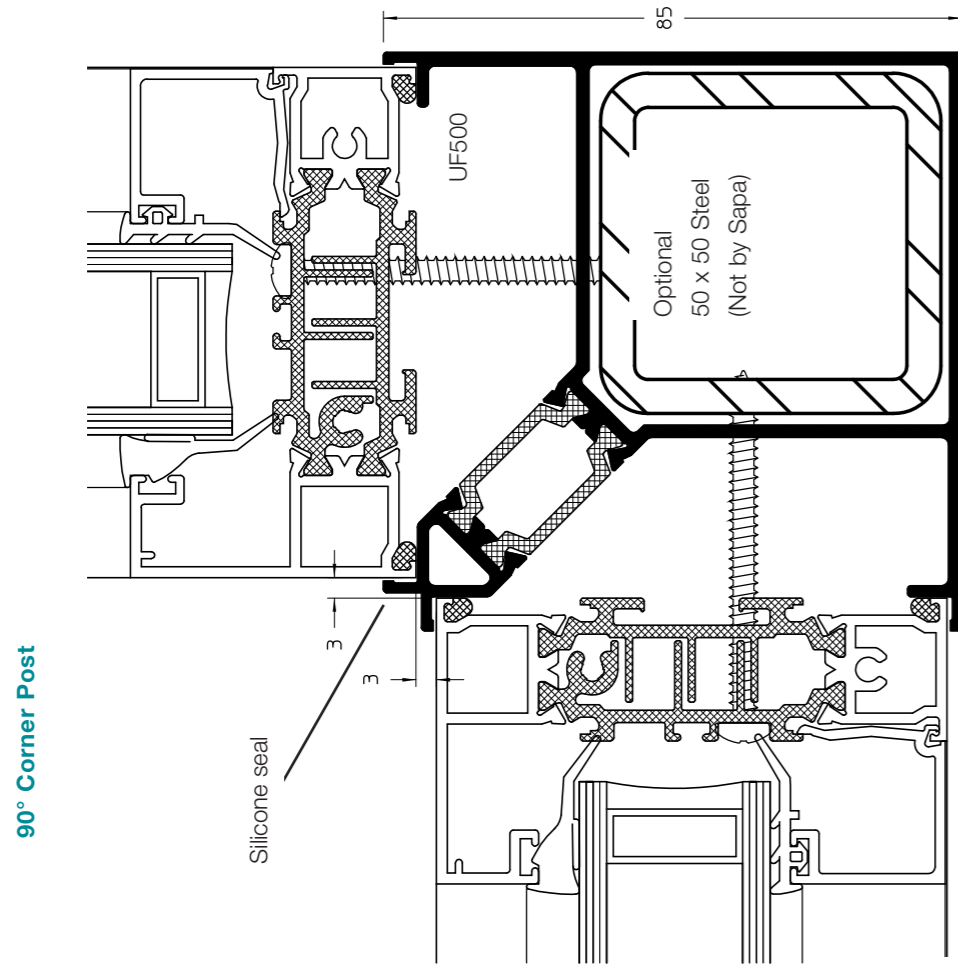

25mm Heavy Duty Coupler

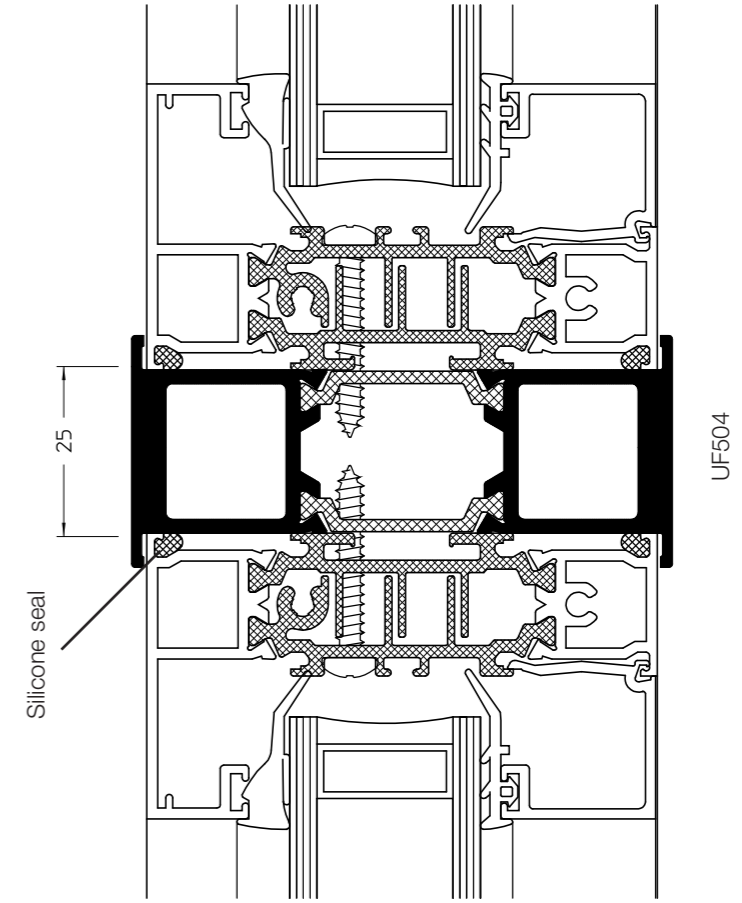

75mm Heavy Duty Coupler

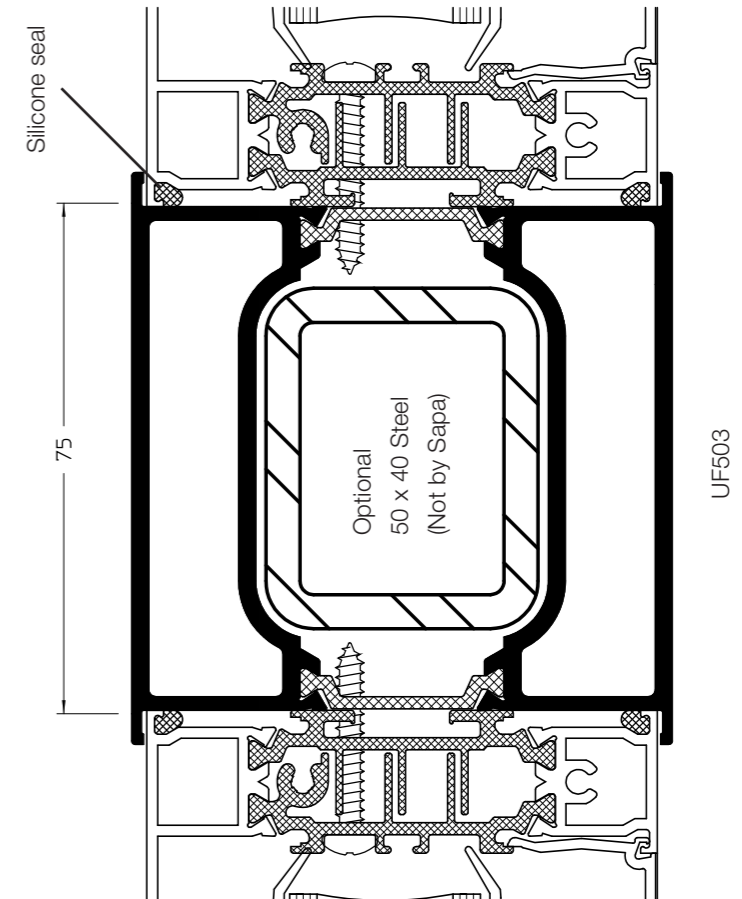

Face Applied Dummy Mullion/Transom

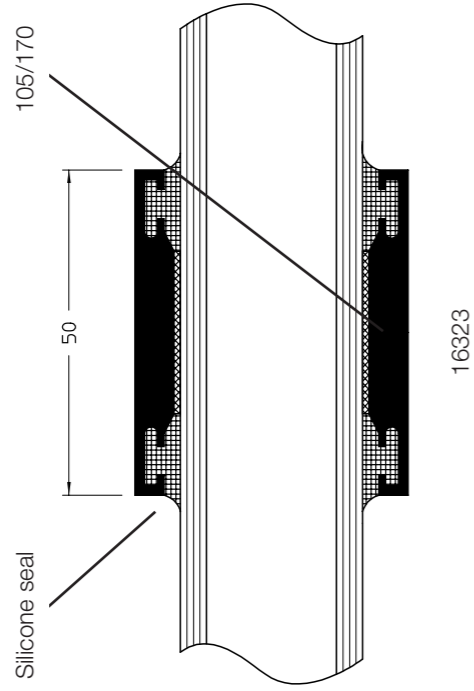

50mm Heavy Duty Coupler

Showing Dualframe 75mm Si Coupled to Dualframe 75mm

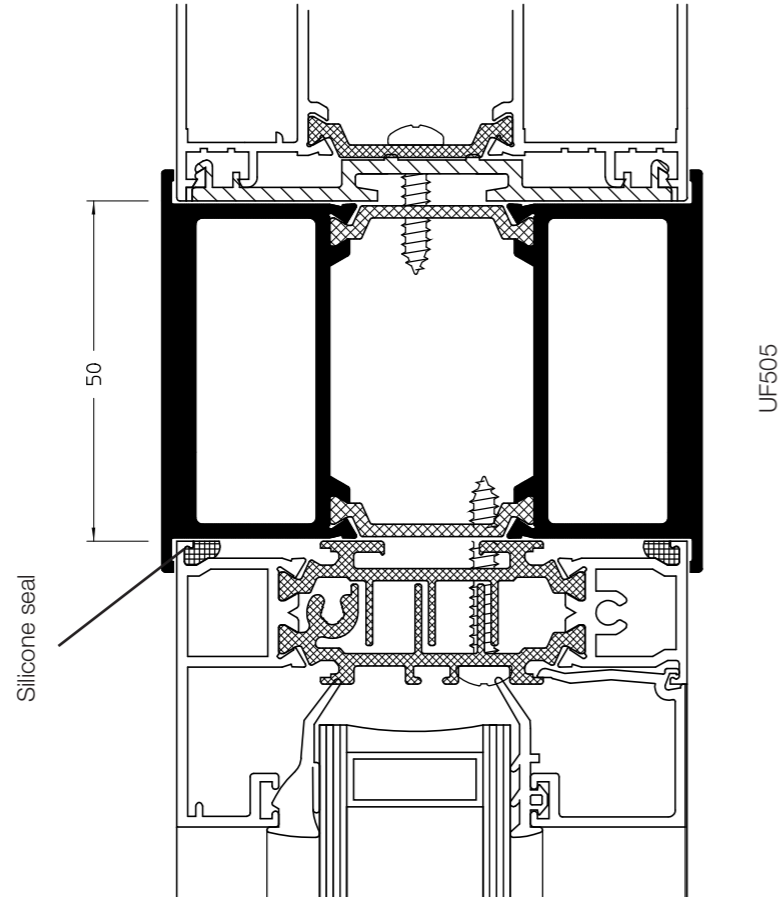

D Reverse Rebate Mullion

Showing outerframe DF1400.
This option is also available for DF1401 outerframe.

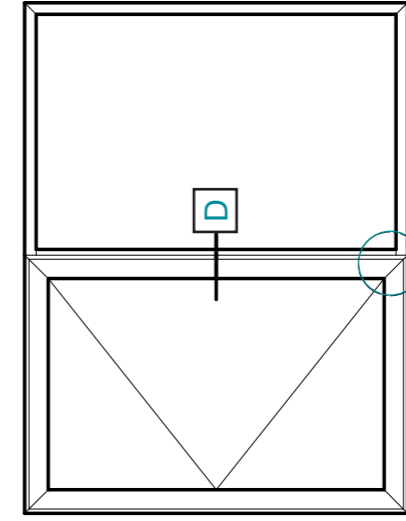
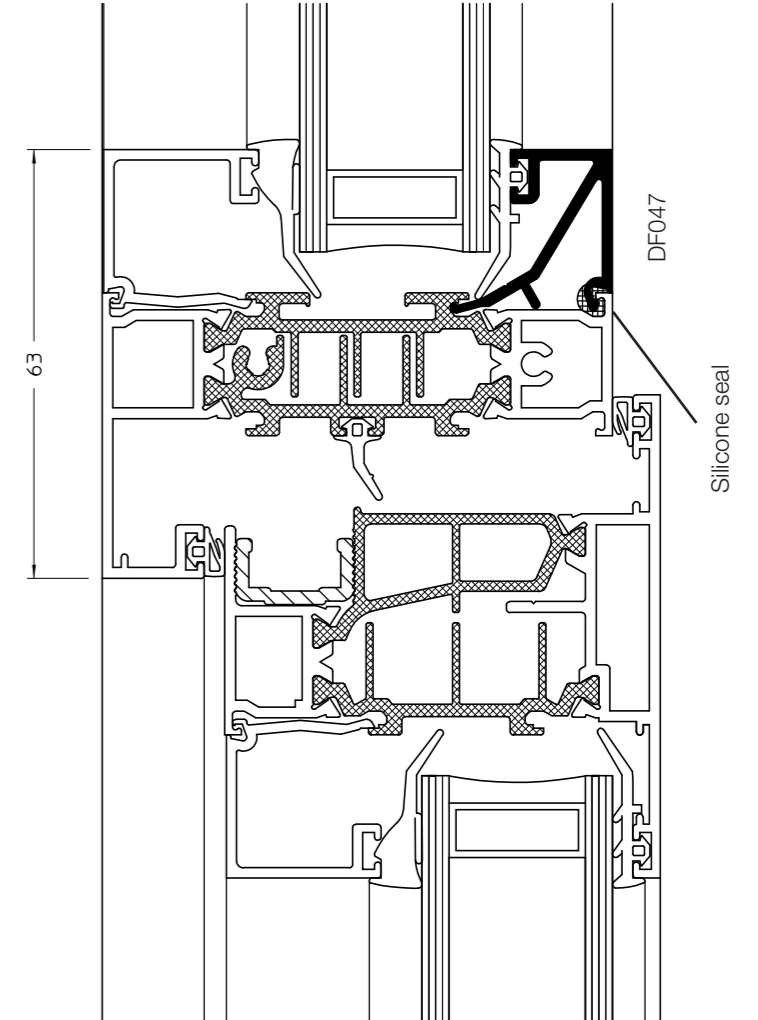

Typical casement window.

This window is manufactured as separate frames, and then joined together.

One frame is a complete rectangular frame of standard construction. The other is goal post shaped.

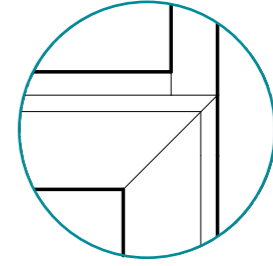

Mullion joint view

Head Vent

Showing optional trickle vent, DF1407 outerframe only.

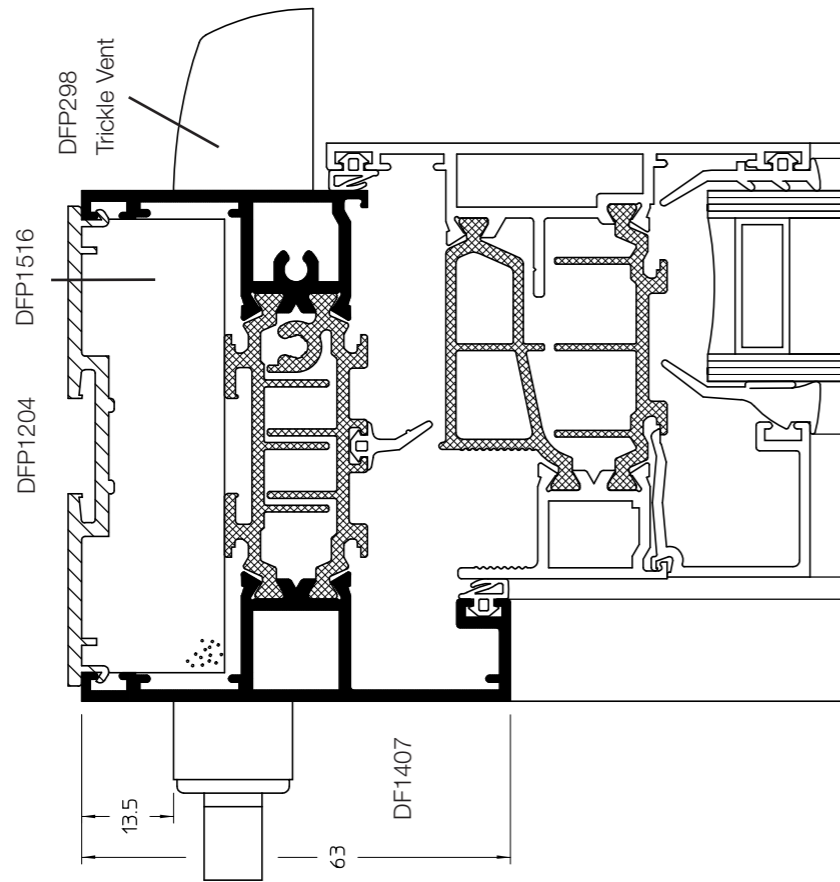

Head Vent Body

Showing optional trickle vent profile, DF1400 frame shown, other frame / vent profile combinations available.

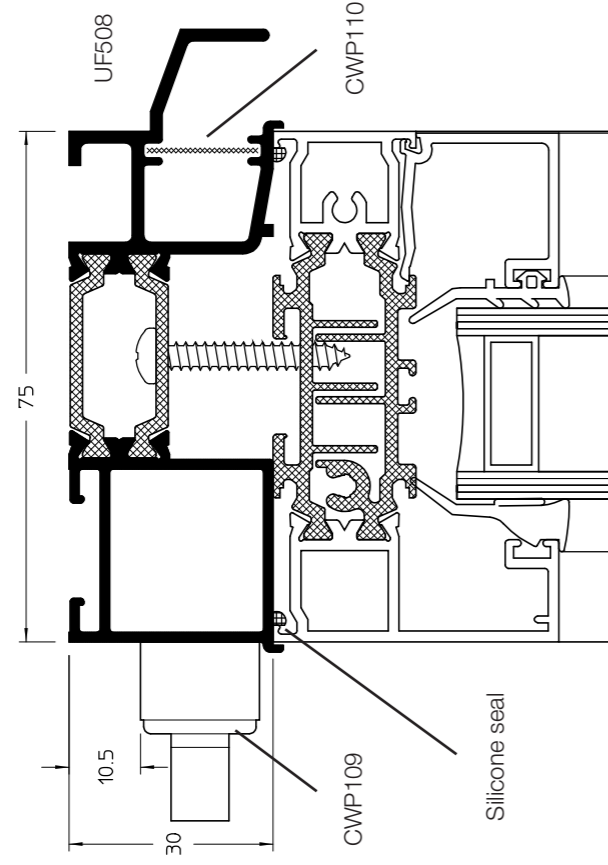

Specialised Range of Profiles

The specialised profile range adds great flexibility when constructing windows where inward and outward facing rebates have to be combined, without the need for coupling sections or dummy frames to fixed lights. These profiles can be used with the standard range of profiles giving even greater scope for construction.

In the example opposite, we have an Si Casement window over an Si TBT window over a glaze-in fixed light, with the centre range of panels being glaze-out, and the end range consisting of a Dualside Window over a glaze-in fixed light.

The frame corners are butt jointed instead of the usual crimping method due to the varying outerframe profiles being used.

The following sectional arrangements highlight an example of how the specialised profiles can be used. Other combinations are possible and the method of construction should be based on consideration of performance, appearance and cost.

The full range of specialised profiles can be found after the sectional details.

Please refer to the specialised section of this manual for machining/assembly.

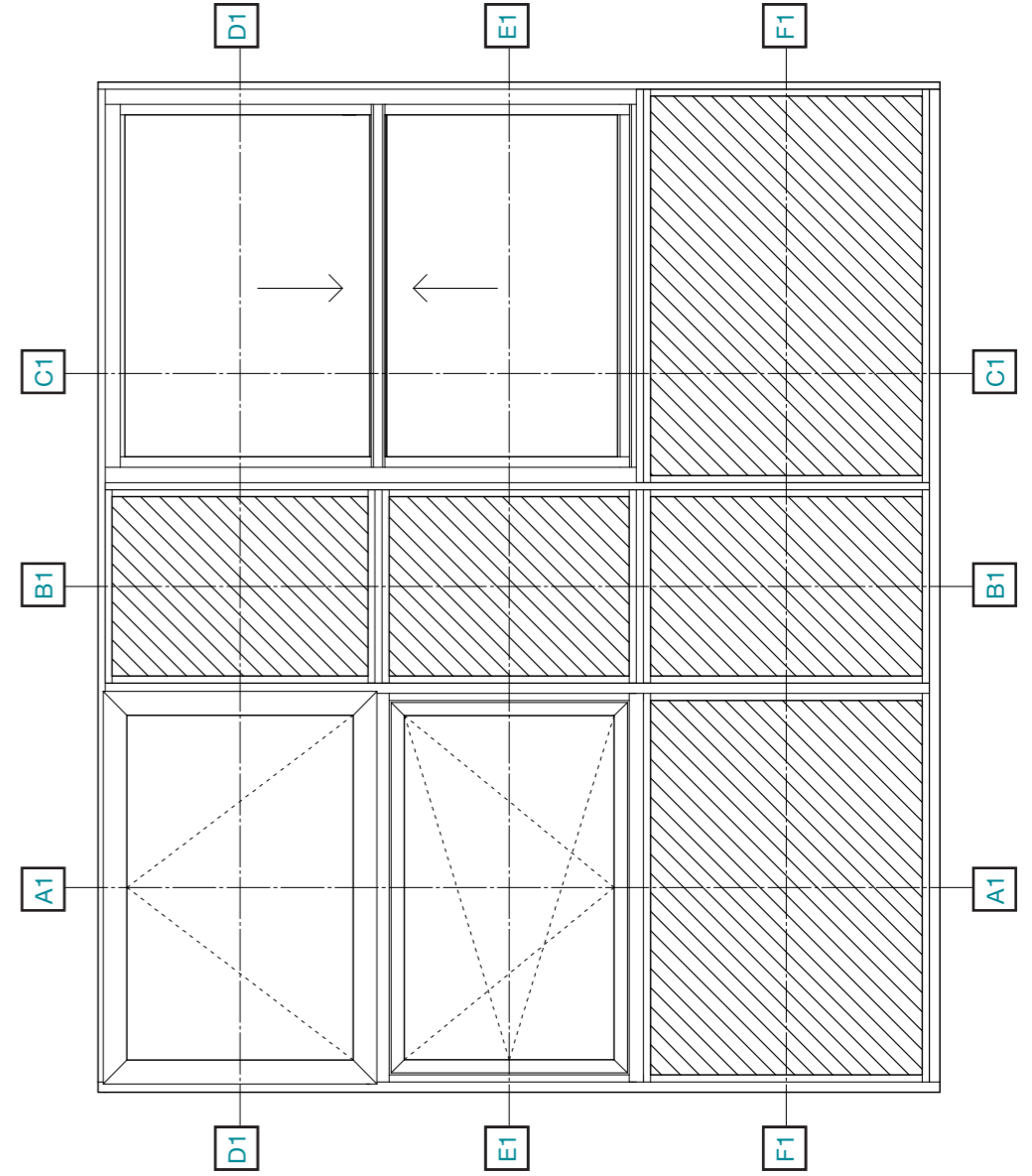

A1 Specialised Profiles

Notice standard
outerframe profile DF1400
being used as a transom

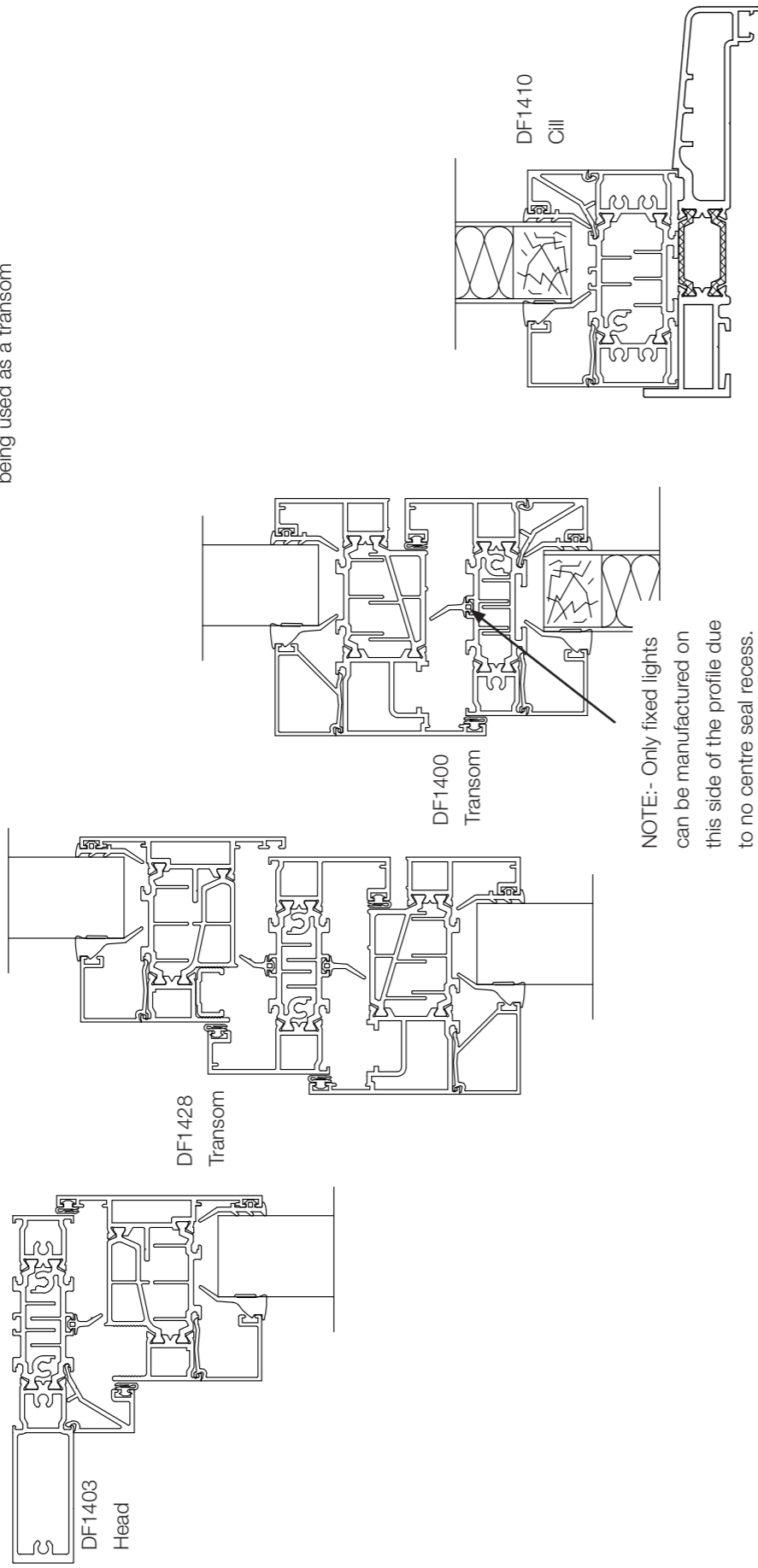

B1 Specialised Profiles

Notice standard
Mullion/transom profile
being used

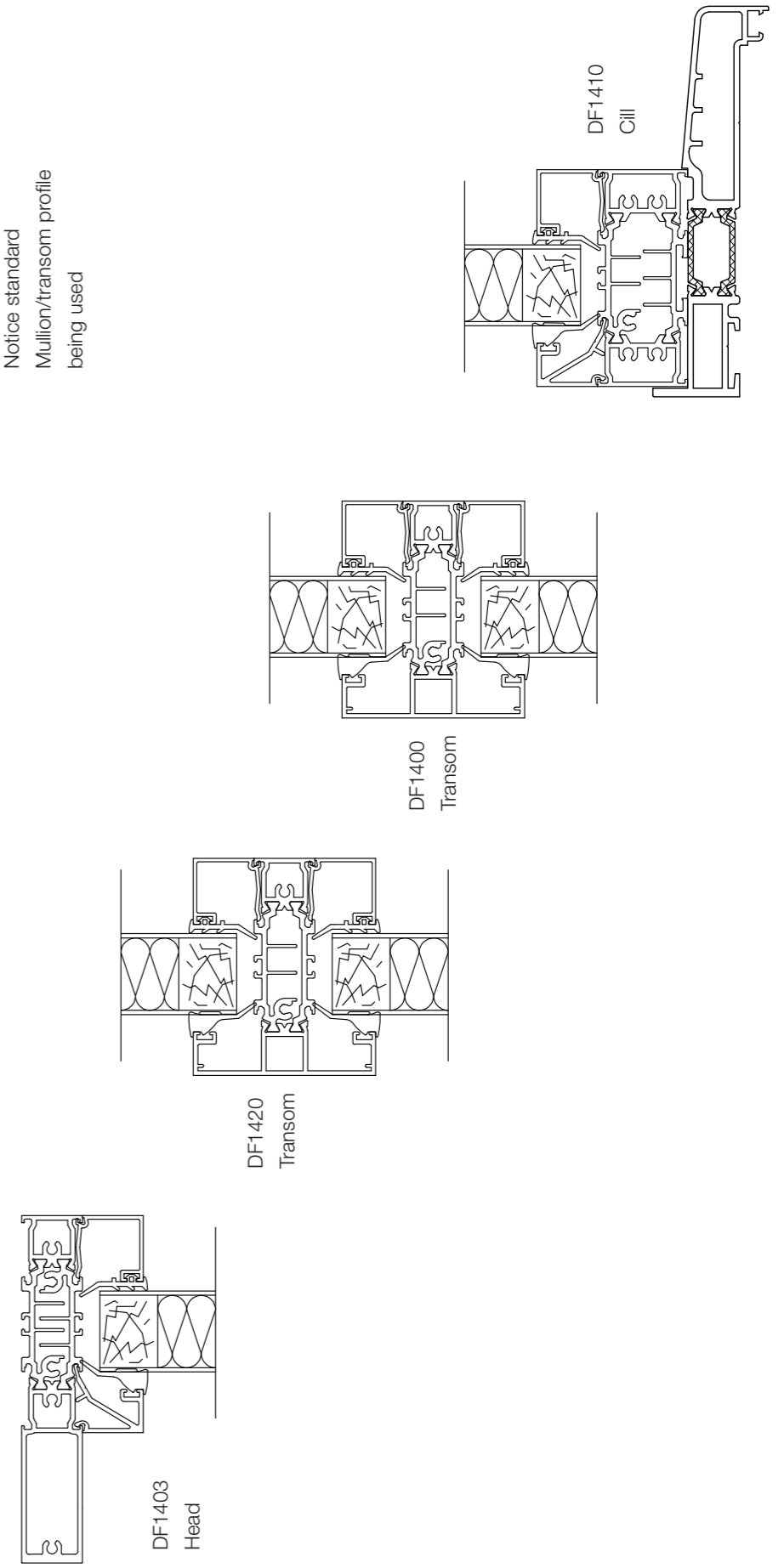

G1 Specialised Profiles

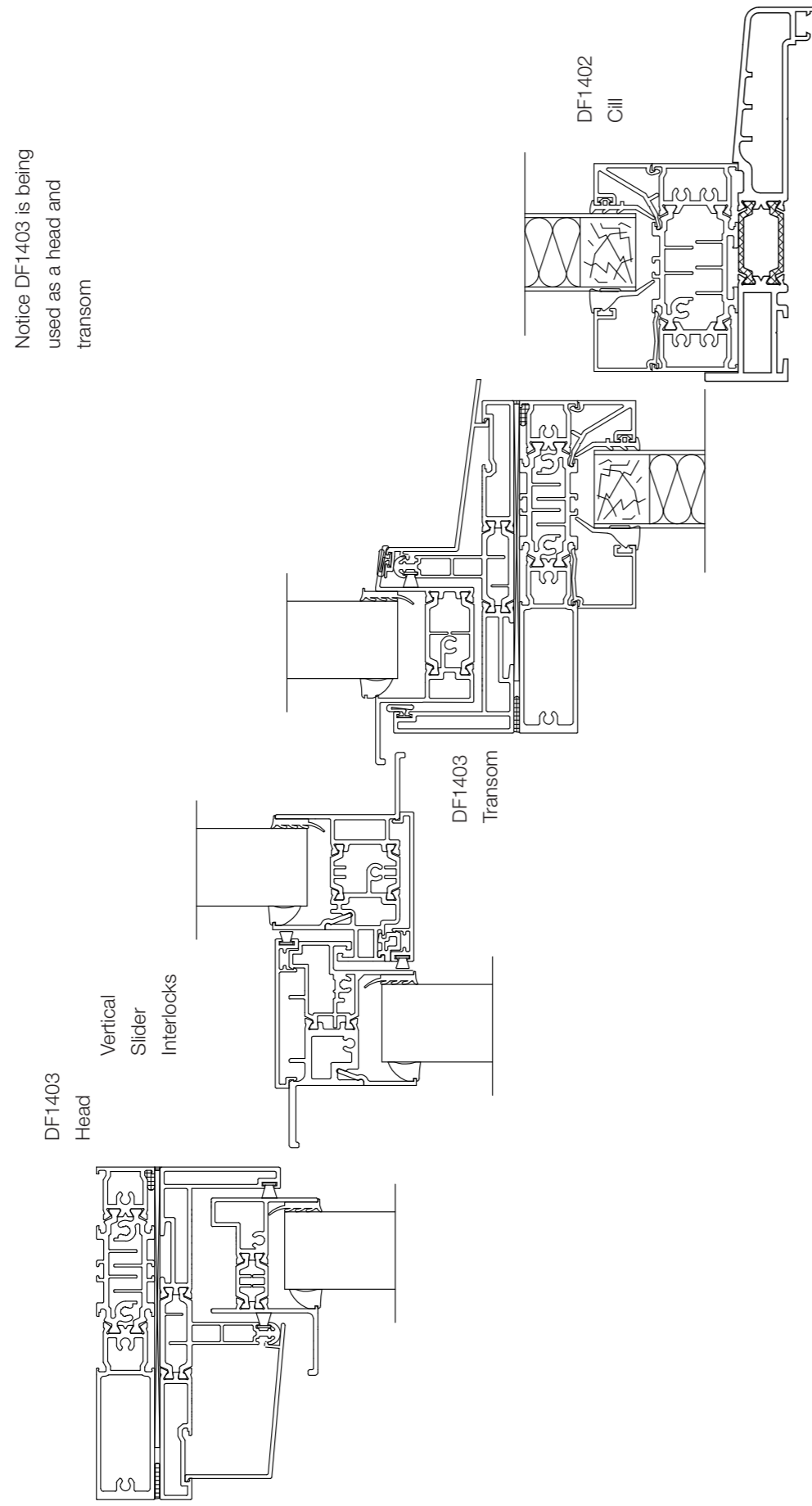

D1 Specialised Profiles

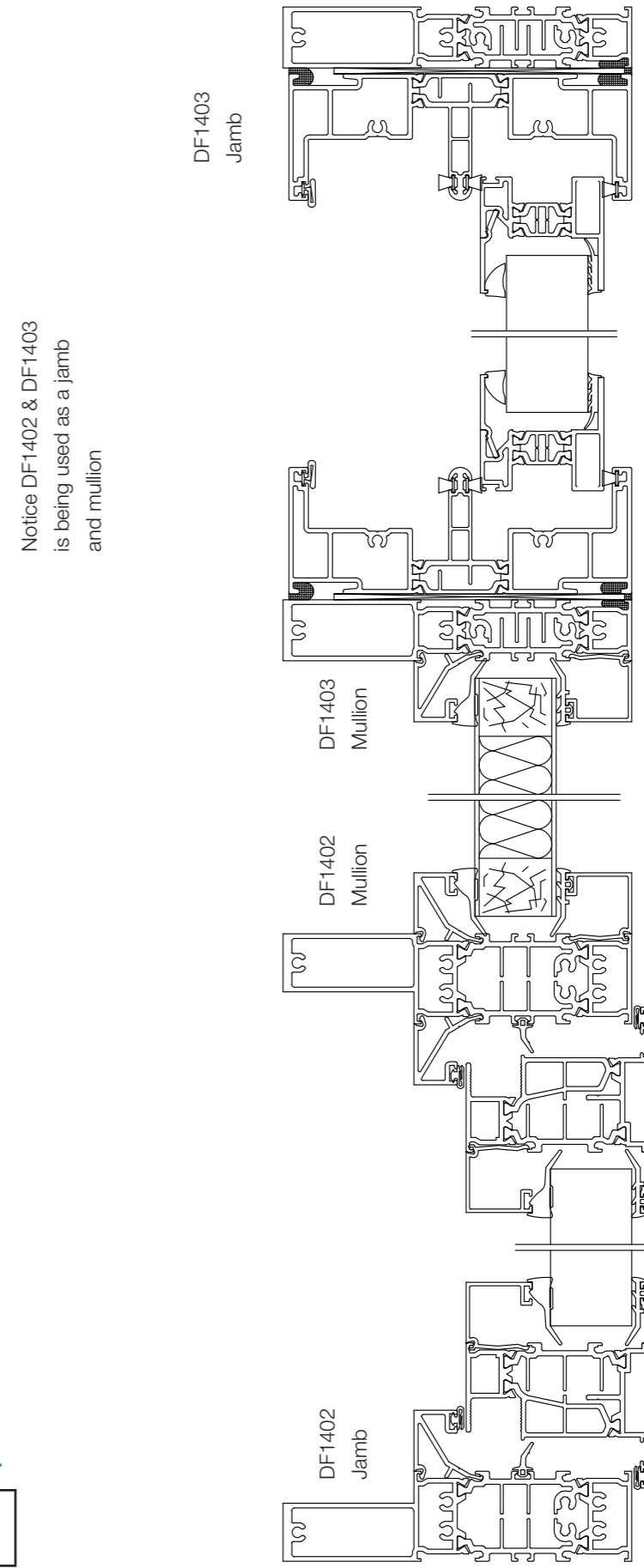

E1 Specialised Profiles

Notice DF1402 & DF1403 is being used as a jamb and mullion

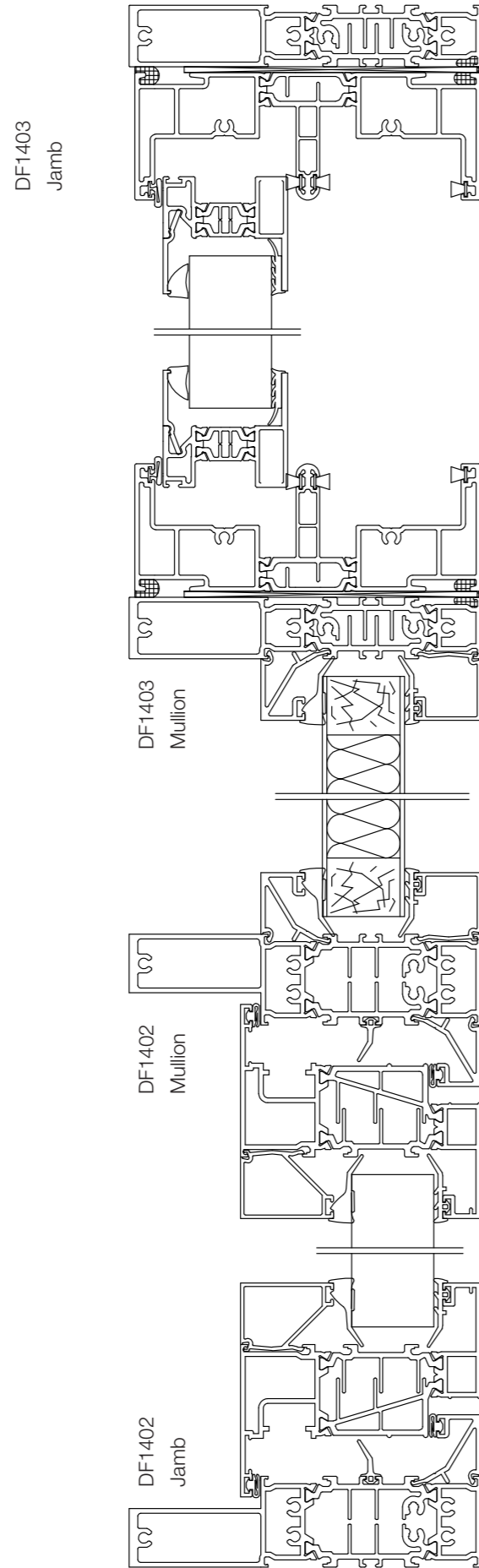

F1 Specialised Profiles

Notice DF1402 & DF1403 is being used as a jamb and mullion

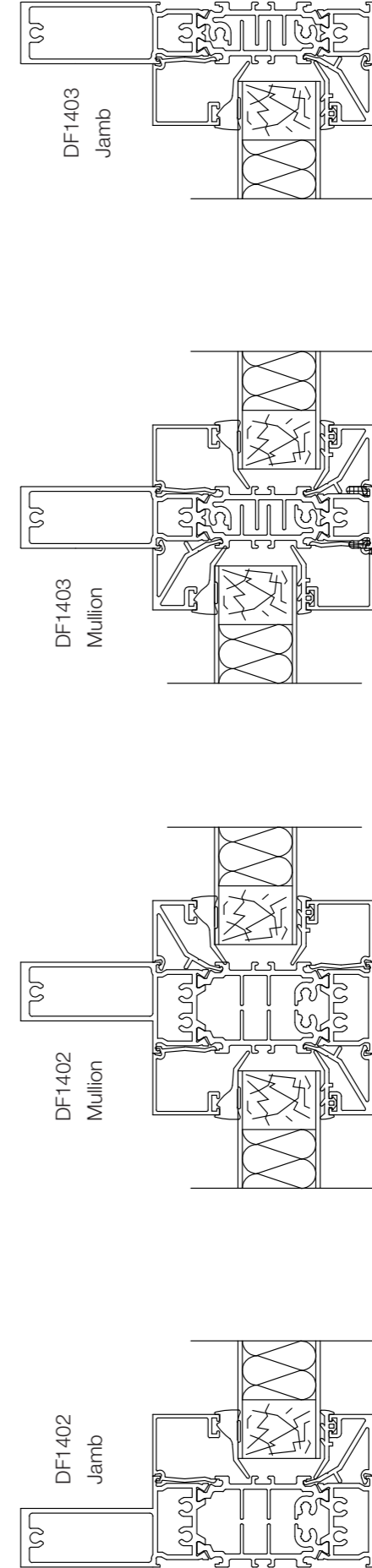

Specialised Profiles Jamb/Vent

Showing universal profile DF1409.
(Reverse rebated for open/glaze out)

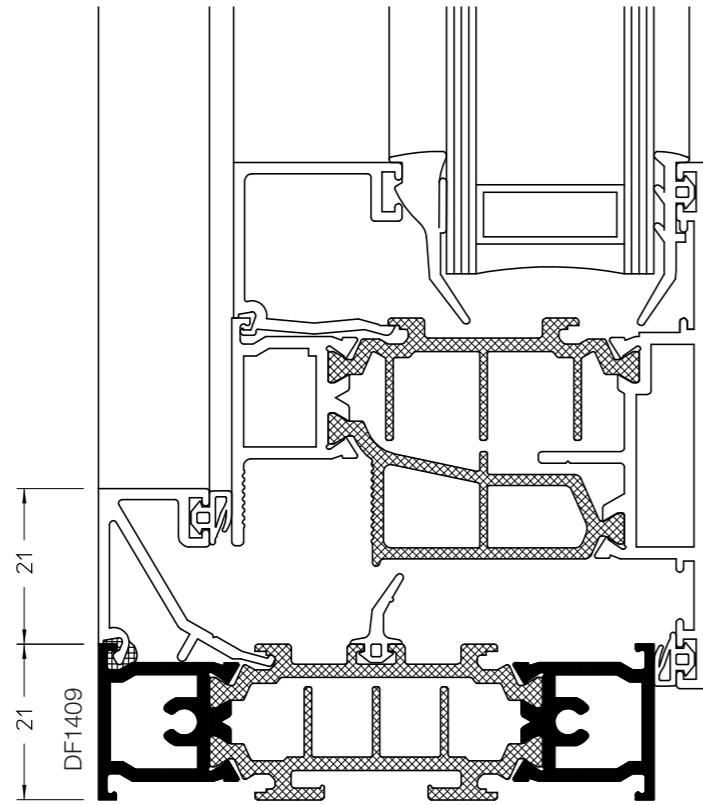

Specialised Profiles HD Jamb/Vent

Showing universal profile DF1410.
(Reverse rebated for open/glaze out)

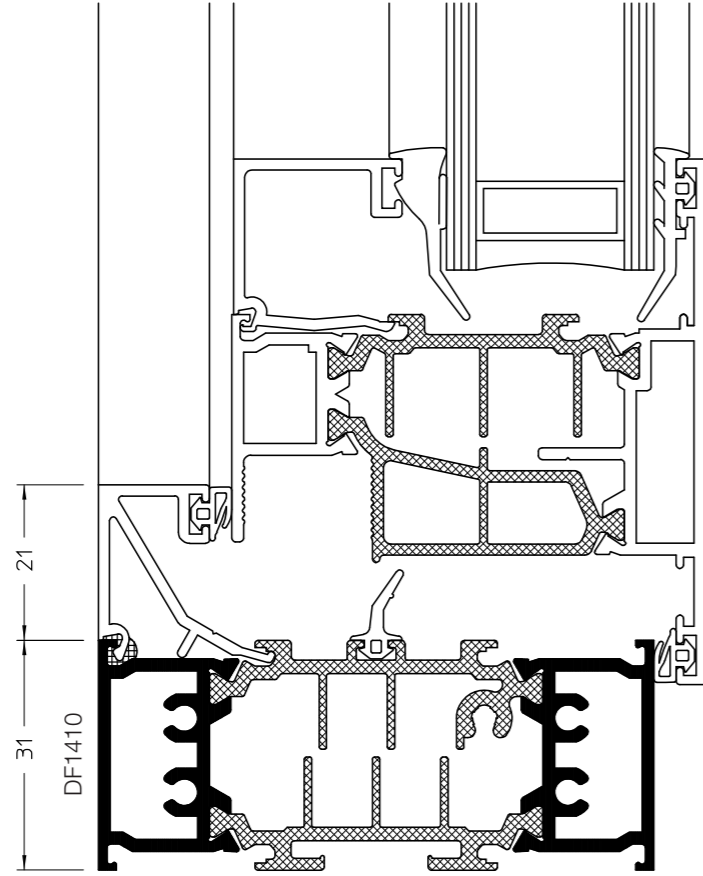

Specialised Profiles Jamb/Vent

Showing universal profile DF1403.
(Reverse rebated for open/glaze out application)

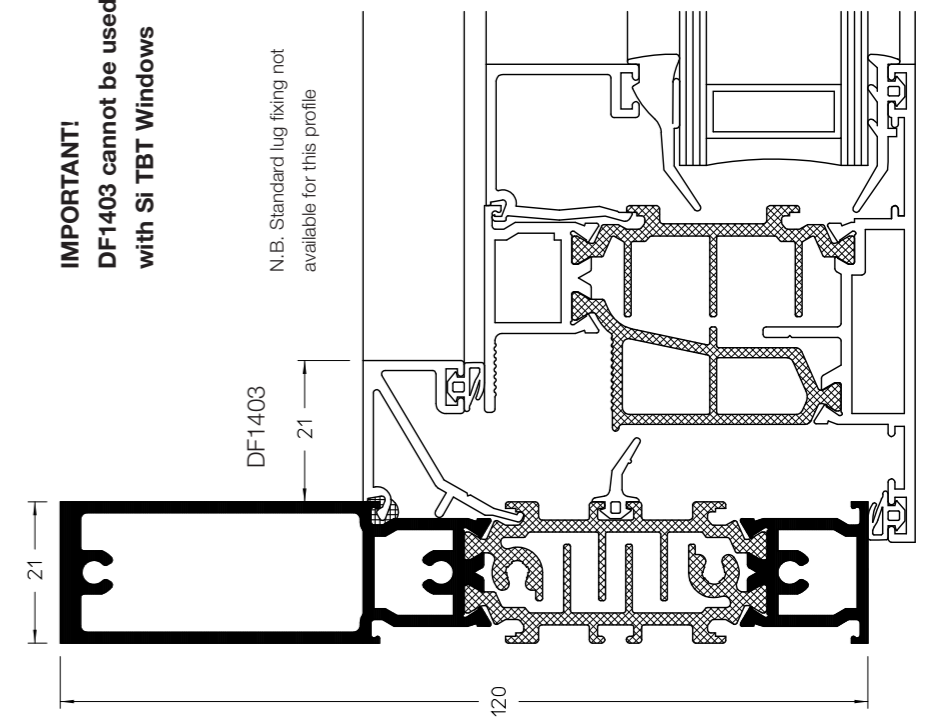

Specialised Profiles HD Jamb/Vent

Showing universal profile DF1402.
(Reverse rebated for open/glaze out application)

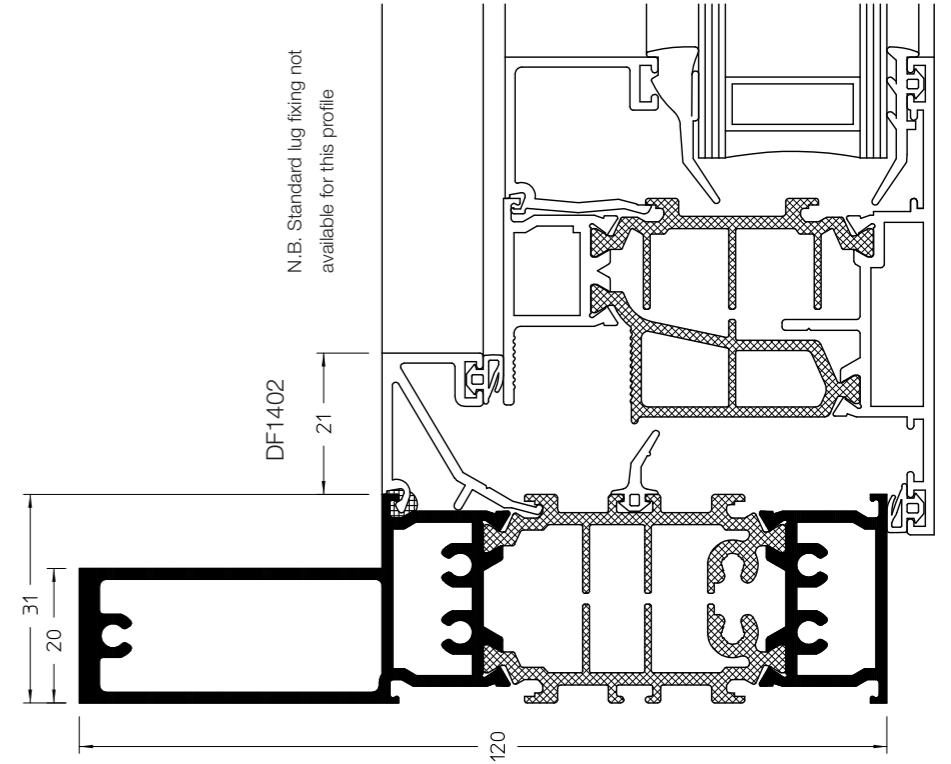

Specialised Profiles Transom/Mullion

Showing universal profile DF1409.
(Reverse rebated for open/glaze out and in applications)

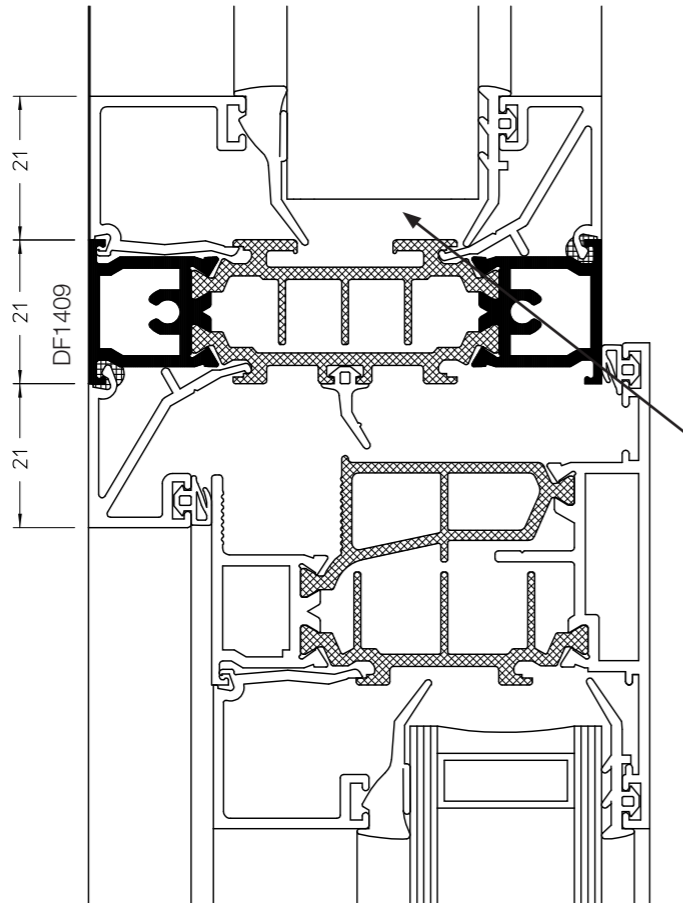

NOTE:- Only fixed lights can be manufactured on this side of the profile due to no centre seal recess.

Specialised Profiles HD Transom/Mullion

Showing universal profile DF1410.
(Reverse rebated for open/glaze out and in applications)

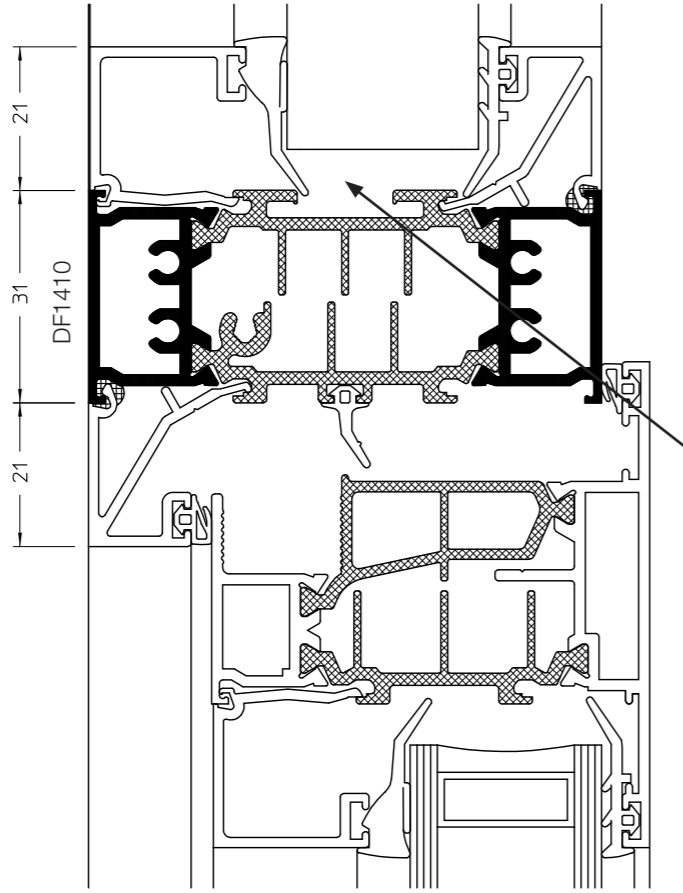

NOTE:- Only fixed lights can be manufactured on this side of the profile due to no centre seal recess.

Specialised Profiles 'Z' Transom/Mullion

Showing universal profile DF1428.

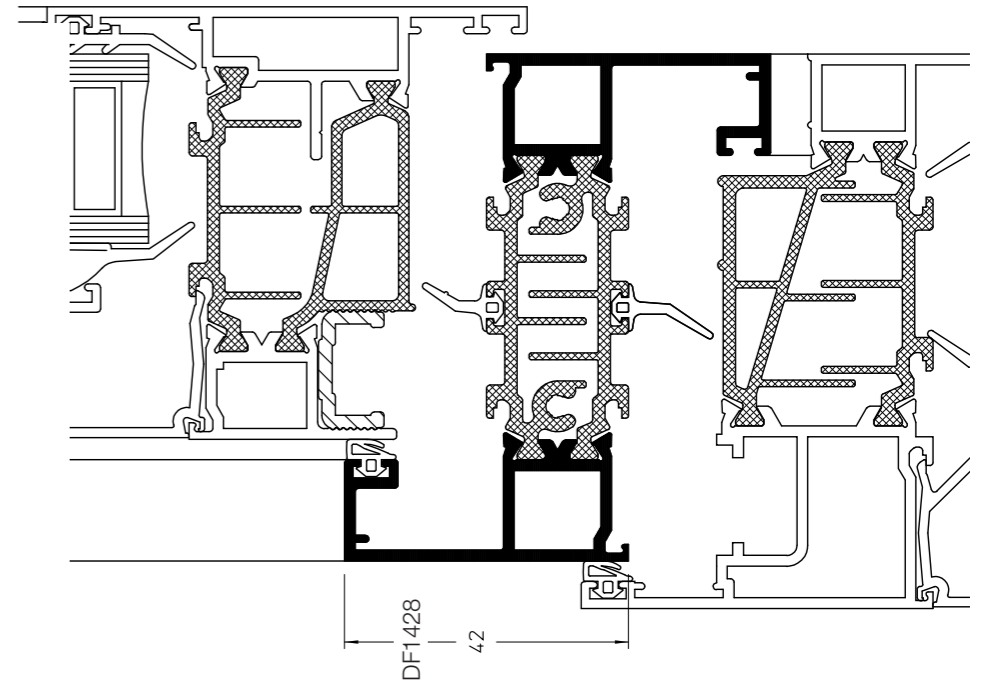

Specialised Profiles 'Z' Transom/Mullion

Showing universal profile DF1429.

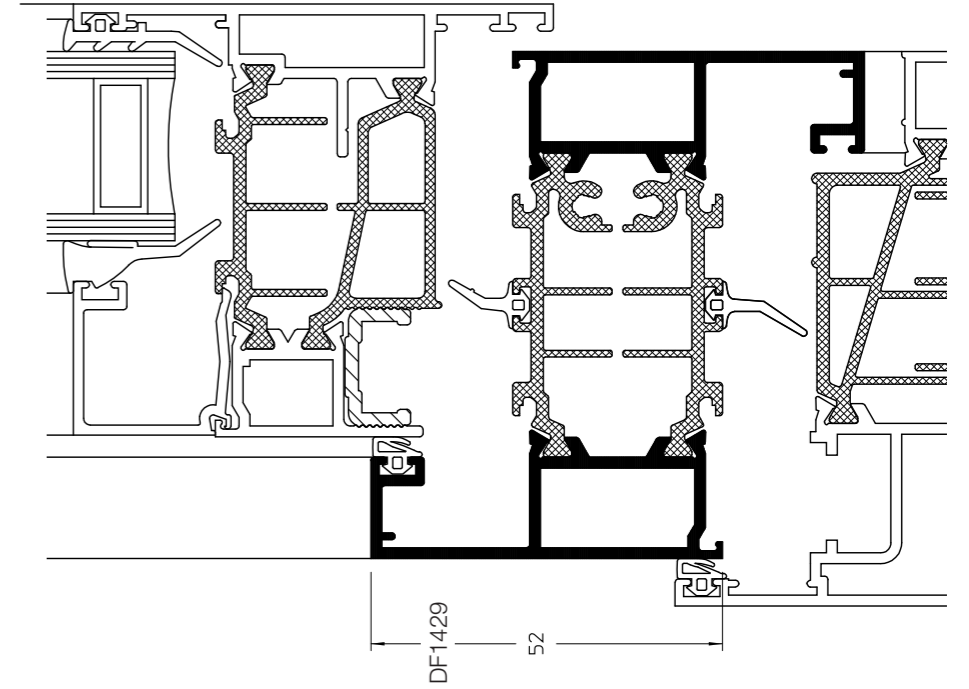



Your local Sapa Building System fabricator

Sapa Building Systems Ltd is a member of the worldwide Sapa Group, which has over 23,500 employees, in more than 40 countries across the globe. The group develops and market high value-added profiles in aluminium and are the leading independent producer of aluminium profiles in the world.

Backed by the resources of the group, Sapa Building System works together with Technal and Wicona to offer architects, specifiers and its customers a wide range of innovative aluminium systems for curtain walling, windows, doors and specialist applications.

Aluminium Curtain Walling, Protection Systems, Windows and Doors

Sapa Building Systems Ltd

Severn Drive, Tewkesbury
Gloucestershire. GL20 8SF
T 01684 853500
F 01684 851850

E info@sapabuildingsystems.co.uk

The Building Centre, 26 Store Street
London. WC1E 7BT
T 0207 636 4186



www.sapabuildingsystems.co.uk